

RENOGY Battery Shunt 300

RSHST-B02P300-G1

VERSION A2
November 22, 2024

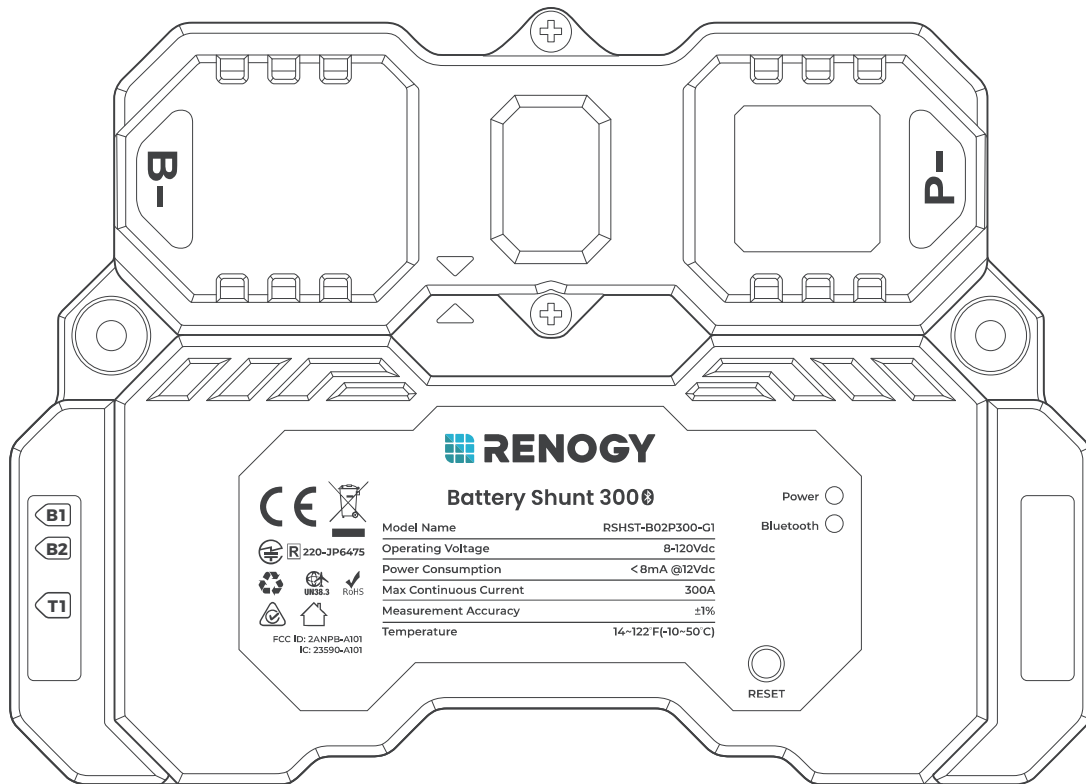

USER MANUAL

Before Getting Started

The user manual provides important operation and maintenance instructions for Renogy Battery Shunt 300 (hereinafter referred to as shunt).

Read the user manual carefully before operation and save it for future reference. Failure to observe the instructions or precautions in the user manual can result in electrical shock, serious injury, or death, or can damage the Renogy Battery Shunt, potentially rendering it inoperable.

- Renogy ensures the accuracy, sufficiency, and the applicability of information in the user manual at the time of printing due to continual product improvements that may occur.
- Renogy assumes no responsibility or liability for personal and property losses, whether directly and indirectly, caused by the user's failure to install and use the product in compliance with the user manual.
- Renogy is not responsible or liable for failures, damages, or injuries resulting from repair attempted by unqualified personnel, improper installation and operation.
- The illustrations in the user manual are for demonstration purposes only. Details may appear slightly different depending on product revision and market region.
- Renogy reserves the right to change the information in the user manual without notice. For the latest user manual, visit [renogy.com](https://www.renogy.com).

Disclaimer

Renogy Battery Shunt 300 User Manual © 2024 Renogy. All rights reserved.

RENOGY and **RENOGY** are registered trademarks of Renogy.

- All information in the user manual is subject to copyright and other intellectual property rights of Renogy and its licensors. The user manual may not be modified, reproduced, or copied, in whole or in part, without the prior written permissions of Renogy and its licensors.
- The registered trademarks in the user manual are the property of Renogy. The unauthorized use of the trademarks is strictly prohibited.

Online Manual



Quick Guide



User Manual



DC Home App



DC Home App



Table of Contents



1. General Information	1
1.1. Symbols Used	1
1.2. Introduction	1
1.3. Key Features	1
1.4. SKU	1
2. Get to Know Renogy Battery Shunt 300	2
2.1. What's In the Box?	2
2.2. Required Tools & Accessories	2
2.3. Product Overview	3
2.4. System Setup	3
3. Preparation	6
3.1. Plan a Mounting Site	6
3.2. Check Renogy Battery Shunt 300	6
3.3. Check System Voltage and Current	7
3.4. Size Bare Wires	7
3.5. How to Install 3/8 in Lugs?	7
4. Installation	9
4.1. Wear Insulating Gloves	9
4.2. Remove the Covers	9
4.3. Connect the Shunt to the Auxiliary Battery Negative	10
4.4. Connect the Shunt to the Device AUX BAT-	10
4.5. Connect the Shunt to the Auxiliary Battery Positive	11
4.6. Install a Battery Temperature Sensor	11
4.7. Connect the Shunt to the Starter Battery Positive (Optional)	12
4.8. Mount the Shunt (Optional)	12
4.9. Install the Covers	13
5. Configuration	14
5.1. Power On	14
5.2. Pairing with DC Home or Renogy ONE	14
5.3. Energy Monitoring	16
5.4. SOC Synchronization	18
5.5. Essential Alarm Settings	20
5.6. Historical Data	22
5.7. Device Info	23
6. LED Indicators	24
7. Troubleshooting	25
8. FAQ	26

9. Dimensions and Specifications.....	27
9.1. Dimensions.....	27
9.2. Technical Specifications.....	27
10. Maintenance.....	29
10.1. Inspection.....	29
10.2. Cleaning.....	29
10.3. Storage.....	29
11. Emergency Responses.....	30
11.1. Fire.....	30
11.2. Flooding.....	30
11.3. Smell.....	30
11.4. Noise.....	30
Renogy Support.....	31
FCC & RSS.....	32
FCC Statement.....	32
FCC Radiation Exposure Statement.....	32
RSS Standard.....	32

1. General Information

1.1. Symbols Used

The following symbols are used throughout the user manual to highlight important information.

-  **WARNING:** Indicates a potentially dangerous condition which could result in injury or death.
-  **CAUTION:** Indicates a critical procedure for safe and proper installation and operation.
-  **NOTE:** Indicates an important step or tip for optimal performance.

1.2. Introduction

Renogy Battery Shunt 300 is an intelligent battery monitor that measures the battery voltage and current based on which it calculates the state of charge (SOC) and remaining running time of the battery.

In addition, the shunt records historical charging and discharging data such as full deep discharge cycle, discharge capacity, charge cycle, and battery temperature.

With the built-in Bluetooth module, Battery Shunt 300 communicates with the DC Home app and Renogy ONE. This allows you to monitor real-time charging and discharging data and customize related parameters. These settings encompass nominal capacity, deep discharge thresholds, temperature alarms, and SOC alarms.

1.3. Key Features

- **Universal Battery Compatibility**
Works seamlessly with various battery types, including Lead Acid (AGM, GEL), Lithium Iron Phosphate, Lithium-ion, and Nickel-metal hybrid.
- **Comprehensive Battery Insights**
Provides vital battery information such as State of Charge (SOC), voltage, current, energy, remaining time, temperature, and starter battery voltage.
- **Alarm and Historical Data**
Records historical data and offers alerts for abnormal conditions through the DC Home app.
- **Convenient Remote Monitoring**
Enables remote monitoring and control via Renogy ONE and the DC Home App using Bluetooth connectivity.
- **Effortless Installation and Configuration**
Simplifies installation and settings adjustments through the DC Home app for a user-friendly experience.

1.4. SKU

Renogy Battery Shunt 300	RSHST-B02P300-G1
--------------------------	------------------

2. Get to Know Renogy Battery Shunt 300

2.1. What's In the Box?

Renogy Battery Shunt 300 × 1

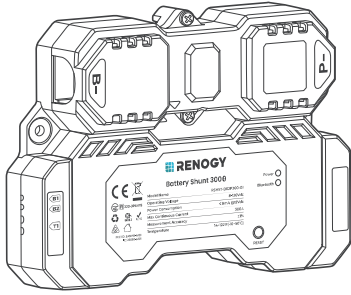

Quick Guide × 1

ST4 x 18 mm

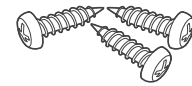

Mounting Screws × 3
(1 extra)

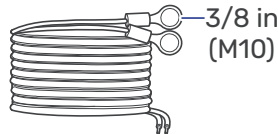

B1/B2 Wires (1 m) (22 AWG) × 2

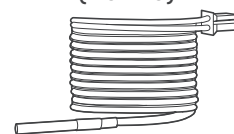

Temperature Sensor (1.5 m) × 1

- i** Make sure that all accessories are complete and free of any signs of damage.
- i** The accessories and product manual listed are crucial for the installation, excluding warranty information and any additional items. Please note that the package contents may vary depending on the specific product model.

2.2. Required Tools & Accessories

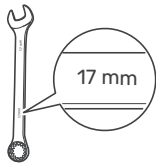

Wrench
(11/16 in)



Phillips
Screwdriver (#1)



Slotted
Screwdriver (1 mm)

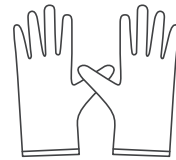

Insulating Gloves



Wire stripper

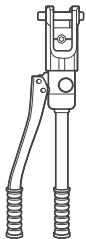

Manual Hydraulic
Pliers

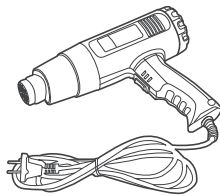

Heat Gun

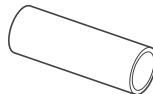

Heat Shrink Tubing



Bare Wires × 2

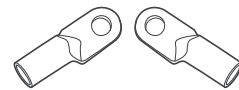

3/8 in Lugs
(M10 Ring Terminals) × 2

- i** Prior to installing and configuring the shunt, prepare the recommended tools, components, and accessories.
- i** For how to size bare wires, refer to [“3.4. Size Bare Wires”](#) in this manual.
- i** For how to install 3/8 in Lugs (M10 Ring Terminals), see [“3.5. How to Install 3/8 in Lugs?”](#) in this manual.
- i** For connection methods and required tools for the auxiliary battery, starter battery, and equipment terminal, please refer to the user manual of the specific device. The diagrams provided within this manual are for illustrative purposes only.

2.3. Product Overview

Exterior

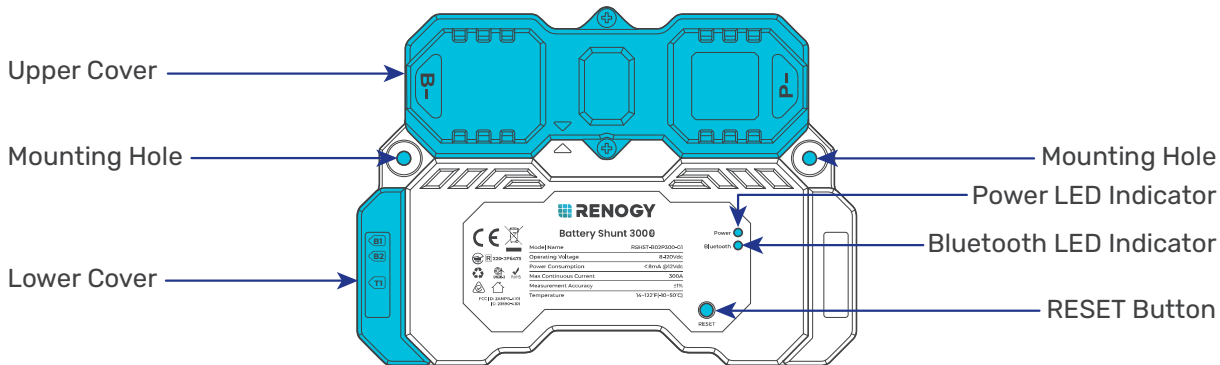

Interior (with the covers removed)

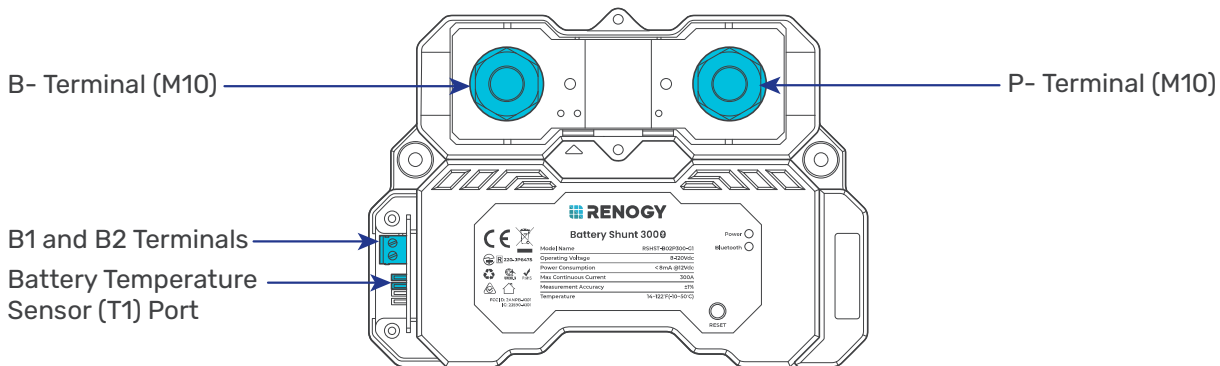

2.4. System Setup

Connecting to a Auxiliary Battery Only

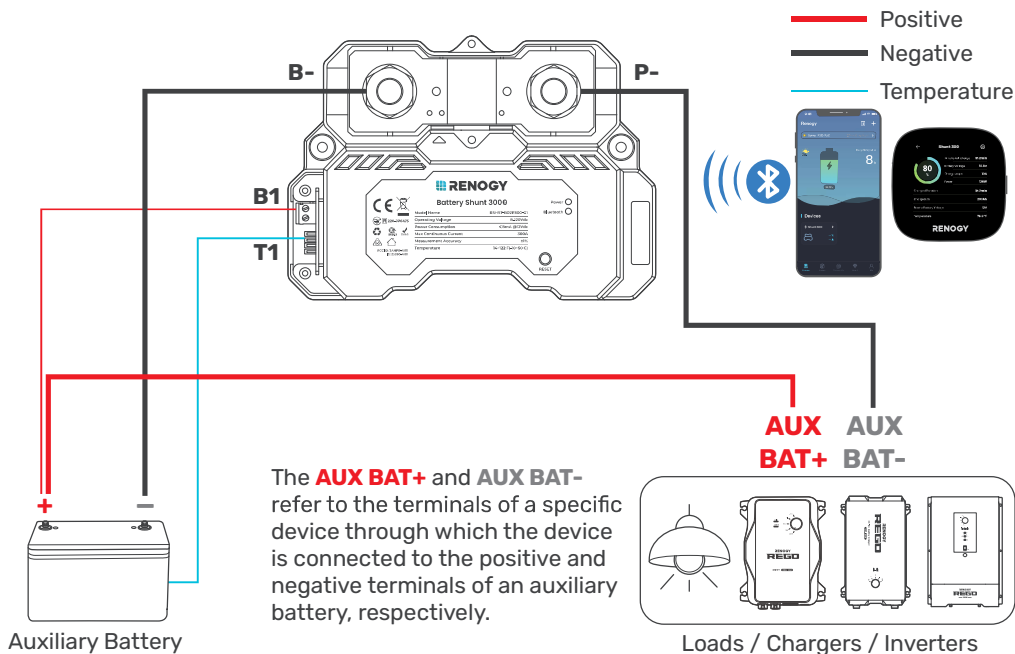

Connecting to Both a Auxiliary Battery and a Starter Battery

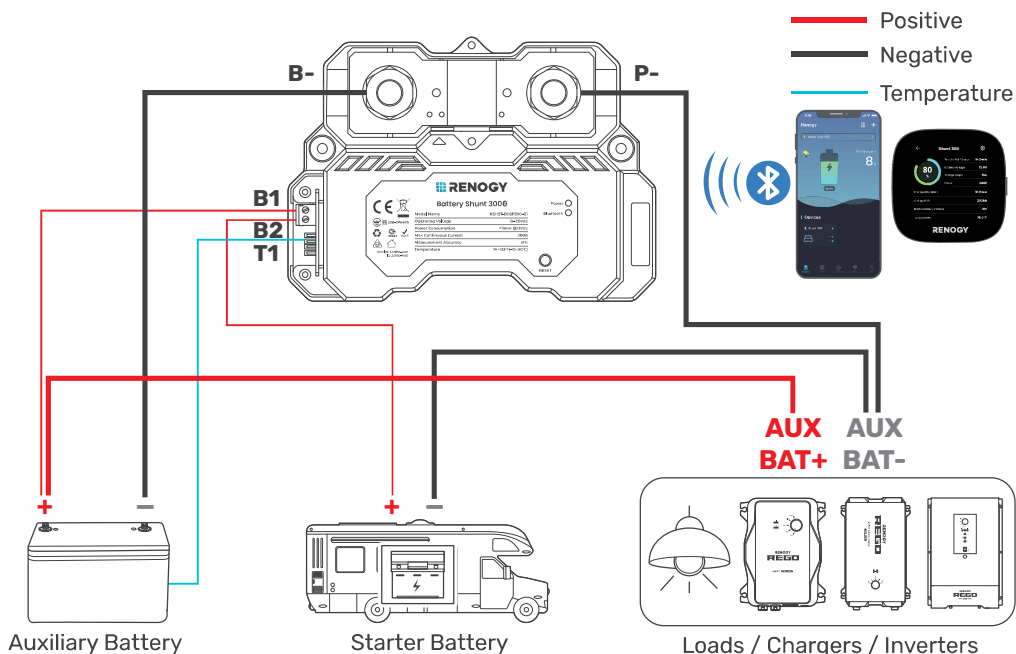

The **AUX BAT+** and **AUX BAT-** refer to the terminals of a specific device through which the device is connected to the positive and negative terminals of an auxiliary battery, respectively.

i In such scenario, the shunt detects voltage of both the auxiliary battery and the starter battery.

Connecting to Multiple Auxiliary Batteries

The illustrations depict two batteries in parallel as an example. There is no limit on the number of batteries in parallel. You can customize the setup with more batteries as needed.

Please ensure the combined continuous current from the batteries must not surpass 300A, maintaining a voltage below 120V.

Auxiliary batteries in parallel

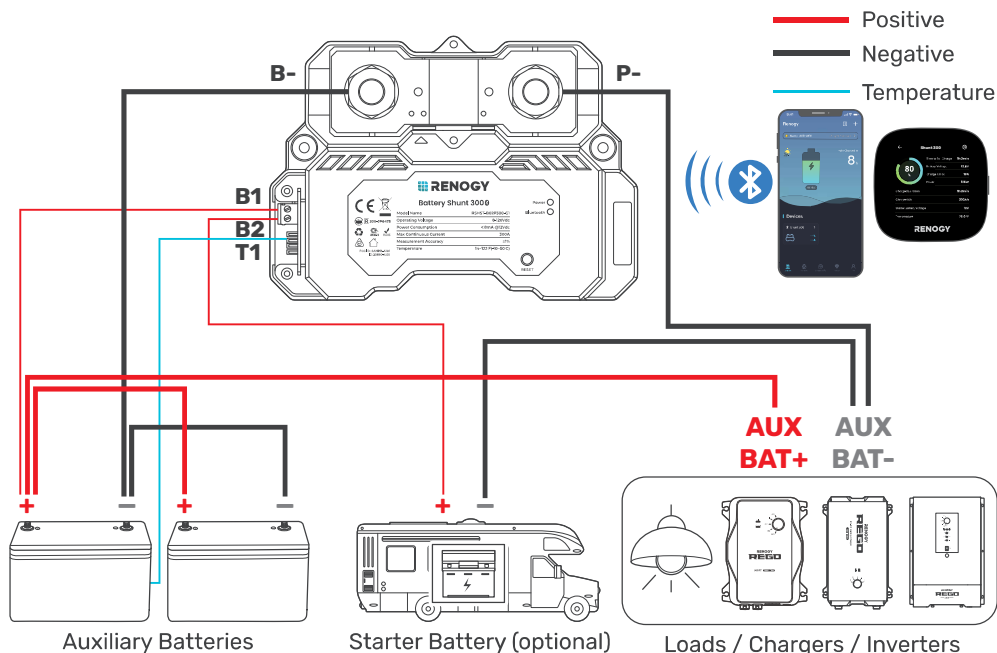

The **AUX BAT+** and **AUX BAT-** refer to the terminals of a specific device through which the device is connected to the positive and negative terminals of an auxiliary battery, respectively.



You can connect the Battery Shunt 300 to a starter battery via the B2 port on demand.

The illustrations depict two batteries in series as an example. There is no limit on the number of batteries in series. You can customize the setup with more batteries as needed.

Please ensure the continuous current from the batteries must not surpass 300A, maintaining a total voltage below 120V.

Auxiliary batteries in series

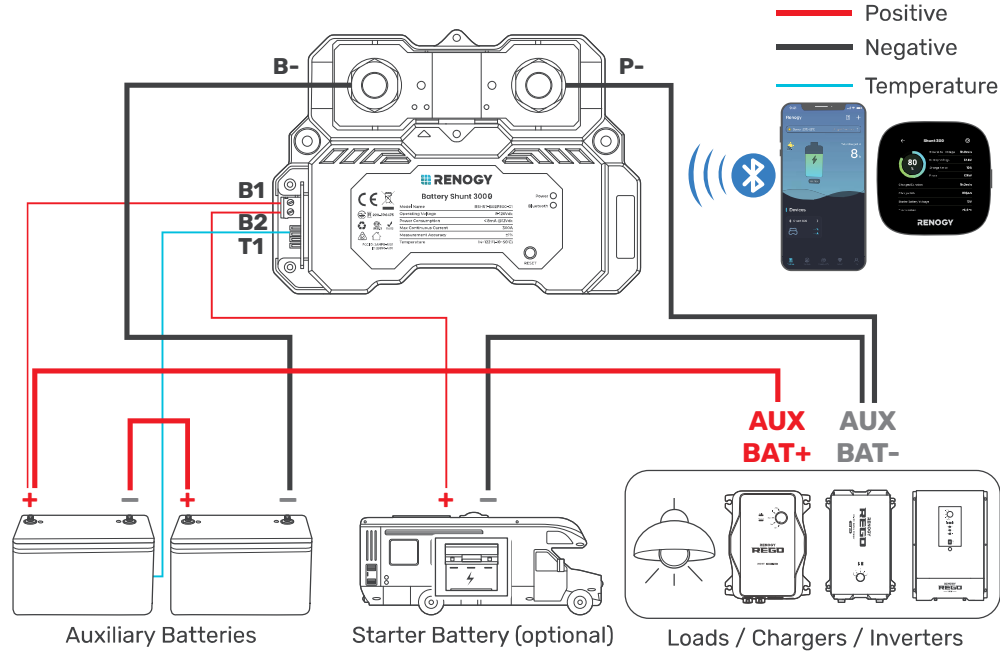

The **AUX BAT+** and **AUX BAT-** refer to the terminals of a specific device through which the device is connected to the positive and negative terminals of an auxiliary battery, respectively.



You can connect the Battery Shunt 300 to a starter battery via the B2 port on demand.

3. Preparation

3.1. Plan a Mounting Site

Select a proper mounting site to ensure the shunt can be safely connected to the battery and other necessary devices with the relevant cables. Install the shunt in a clean, cool, and dry location, free from any accumulation of water, oil, or dirt. For optimal Bluetooth communication, avoid placing the battery shunt near metal objects.

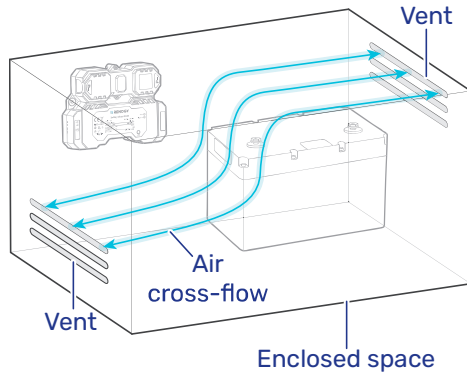

- ⚠ Install the Renogy Battery Shunt 300 indoors and prevent its components from being exposed to direct sunlight.
- ⚠ Do not expose Renogy Battery Shunt 300 to flammable or harsh chemicals or vapors.
- ⚠ Keep Renogy Battery Shunt 300 out of the reach of children.
- ⚠ Make sure that the Renogy Battery Shunt 300 is installed with ambient temperature range from -4°F to 122°F or -20°C to 50°C.
- ⚠ Make sure that the Renogy Battery Shunt 300 is installed in an environment with relative humidity between 0% and 95% and no condensation.

3.2. Check Renogy Battery Shunt 300

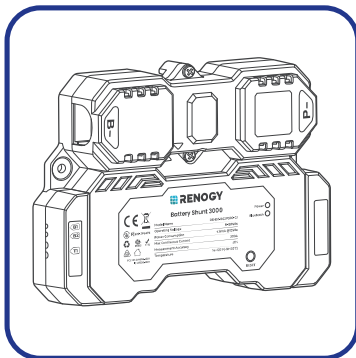

Inspect the shunt for any visible damage including cracks, dents, deformation, and other visible abnormalities. All connector contacts shall be clean, dry, and free of dirt and corrosion.

- ⚠ Do not use Renogy Battery Shunt 300 if it appears to be damaged.
- ⚠ There are no serviceable parts in Renogy Battery Shunt 300. Do not open, dismantle, repair, tamper with, or modify it.
- ⚠ Wear proper protective equipment and use insulated tools during installation.
- ℹ Do not dispose of Renogy Battery Shunt 300 as household waste. Comply with local, state, and federal laws and regulations and use recycling channels as required.

3.3. Check System Voltage and Current

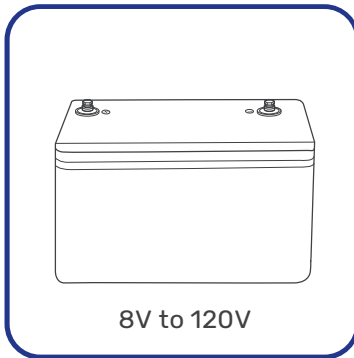

Ensure the battery shunt operates within a power system with a maximum system voltage of 120V and a continuous current of up to 300A. Exceeding these voltage and current limits may cause damage to the shunt.

! Risk of electric shock! Before installing the shunt, please turn off all devices within the system and ensure there is no current flowing through the circuit.

3.4. Size Bare Wires

Select proper bare wires based on the ampacity in your power system. Refer to the table below for copper cable ampacities with different gauge sizes.

Cable Gauge Size	Ampacity	Cable Gauge Size	Ampacity
14 AWG (2.08 mm ²)	35A	2 AWG (33.6 mm ²)	190A
12 AWG (3.31 mm ²)	40A	1 AWG (42.4 mm ²)	220A
10 AWG (5.25 mm ²)	55A	1/0 AWG (53.5 mm ²)	260A
8 AWG (8.36 mm ²)	80A	2/0 AWG (67.4 mm ²)	300A
6 AWG (13.3 mm ²)	105A	4/0 AWG (107 mm ²)	405A
4 AWG (21.1 mm ²)	140A		

i The above values are from the NEC Table 310.17 for copper cables rated at 194°F (90°C), operating at an ambient temperature of no more than 86°F (30°C). Cables longer than 13 feet (4000 mm) may require thicker gauge wires to prevent excessive voltage drop in undersized wiring.

3.5. How to Install 3/8 in Lugs?

If a suitable battery tray cable isn't available, you can customize one by following the steps below:

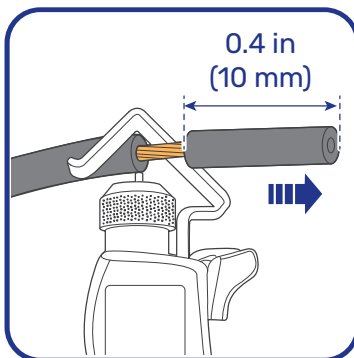

Step 1: Strip approximately 0.4 inches (10 mm) of insulation from the end of a bare wire using a wire stripper.

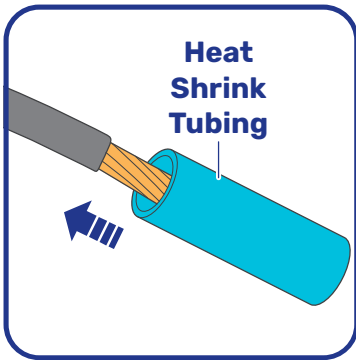

Step 2: Thread the exposed bare wire through a piece of heat shrink tubing.

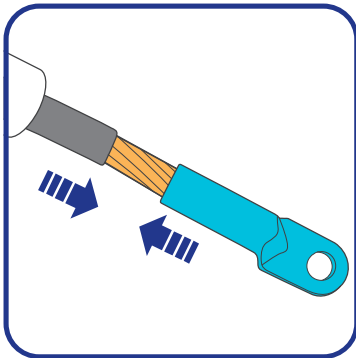

Step 3: Attach a 3/8-inch lug onto the end of the bare wire.

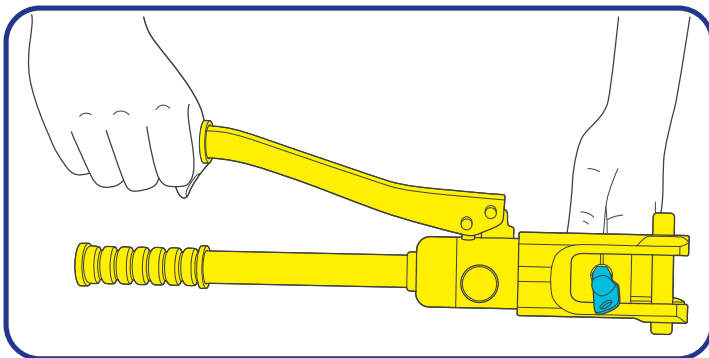

Step 4: Securely crimp the lug onto the bare wire using a manual hydraulic pliers.

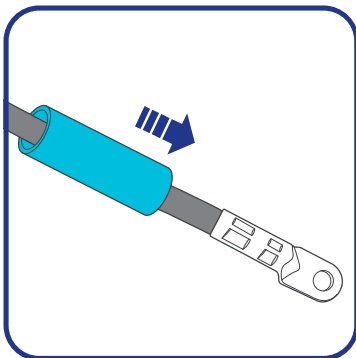

Step 5: Slide the heat shrink tubing over the 3/8-inch lug.

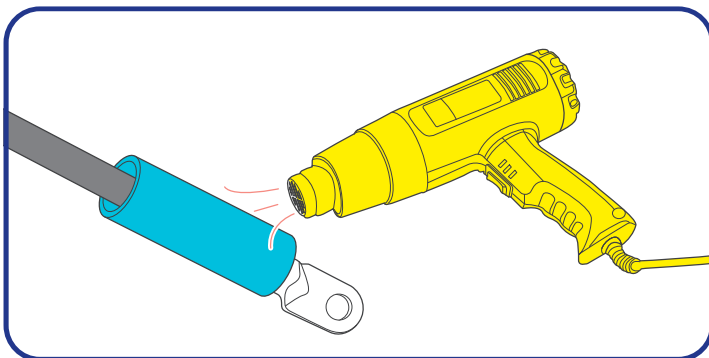

Step 6: Apply heat to the heat shrink tubing using a heat gun until it shrinks and forms a tight seal.

4. Installation

To ensure safe and efficient operation of the battery shunt and to avoid potential damage or hazards, always follow the installation instructions in the sequence described in this manual.

4.1. Wear Insulating Gloves

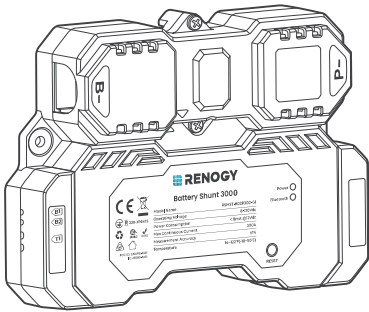

Insulating Gloves

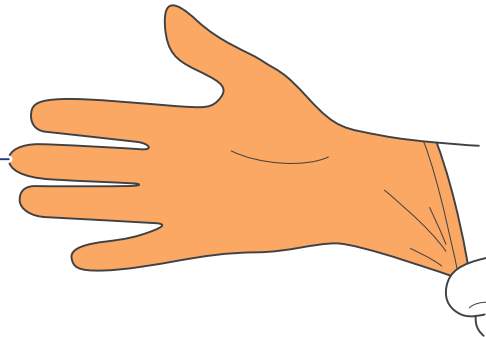

4.2. Remove the Covers

Remove the Upper Cover

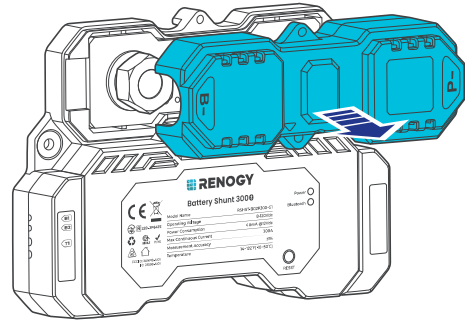
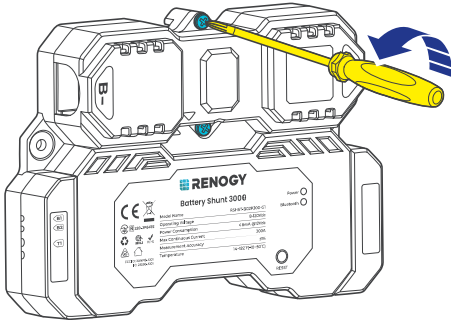

Remove the Lower Cover

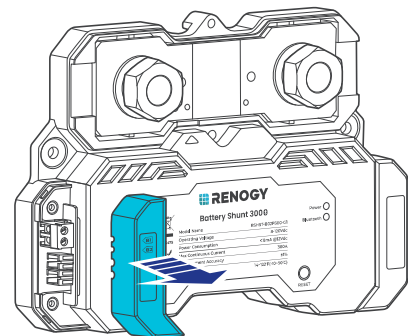
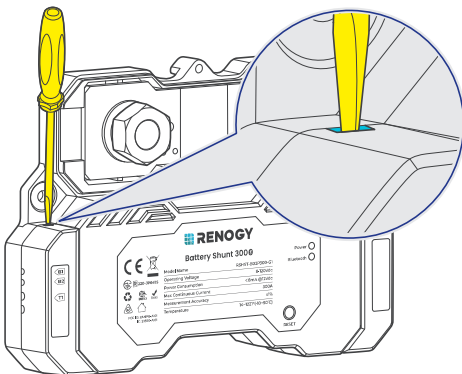

4.3. Connect the Shunt to the Auxiliary Battery Negative

STEP-1 Install the bare wire on the shunt B- terminal.

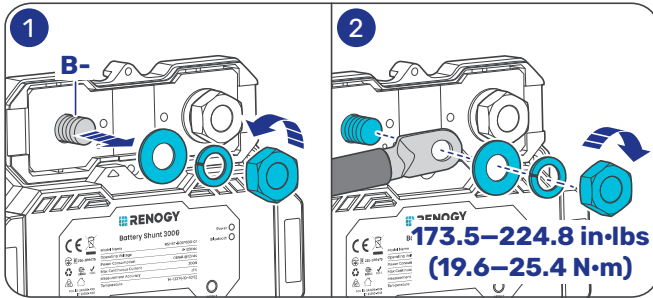

Renogy Battery Shunt 300

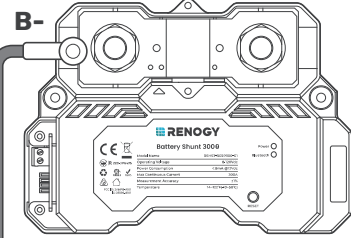

Bare Wire

STEP-2 Install the bare wire on the battery negative.

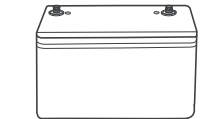
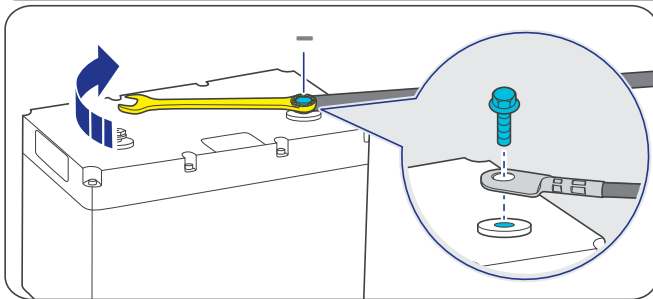

Auxiliary Battery

4.4. Connect the Shunt to the Device AUX BAT-

STEP-1 Install the bare wire on the shunt P- terminal.

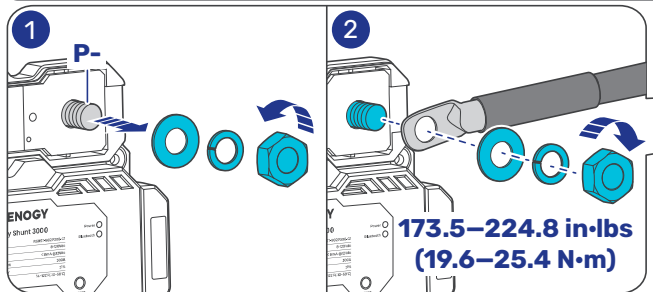

Renogy Battery Shunt 300

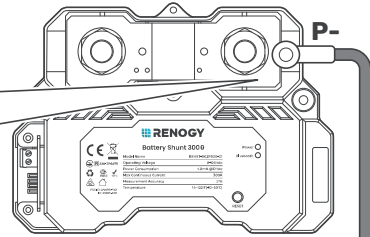

Bare Wire

STEP-2 Install the bare wire on the device AUX BAT-.

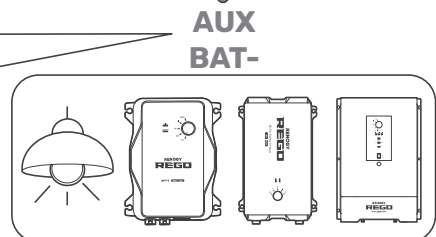
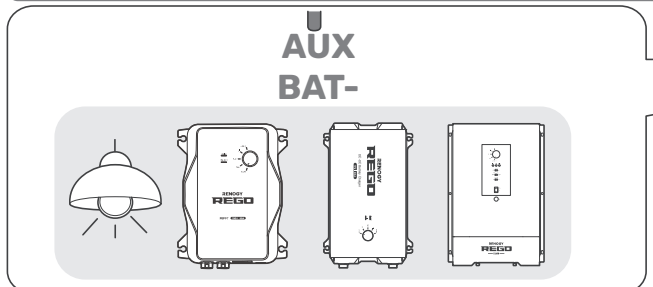

Loads & Charges & Inverters

4.5. Connect the Shunt to the Auxiliary Battery Positive

STEP-1 Install the B+ wire on the shunt B1 terminal.

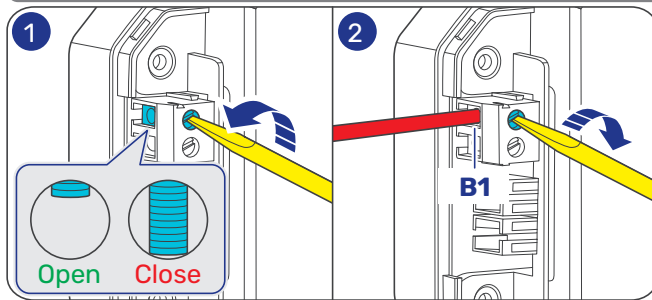

Renogy Battery Shunt 300

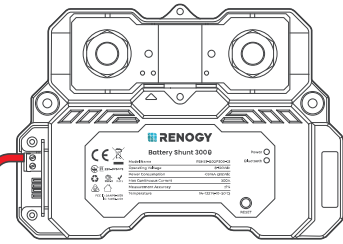

B1 Wire

STEP-2 Install the B+ wire on the auxiliary battery positive.

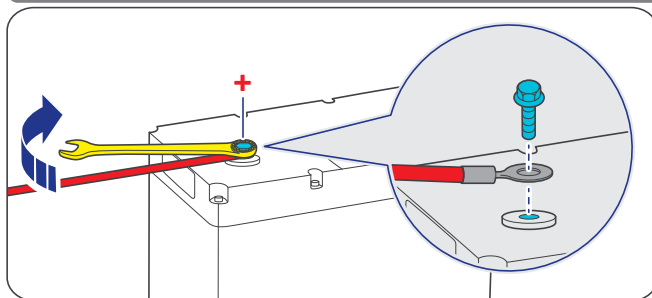

Auxiliary Battery

4.6. Install a Battery Temperature Sensor

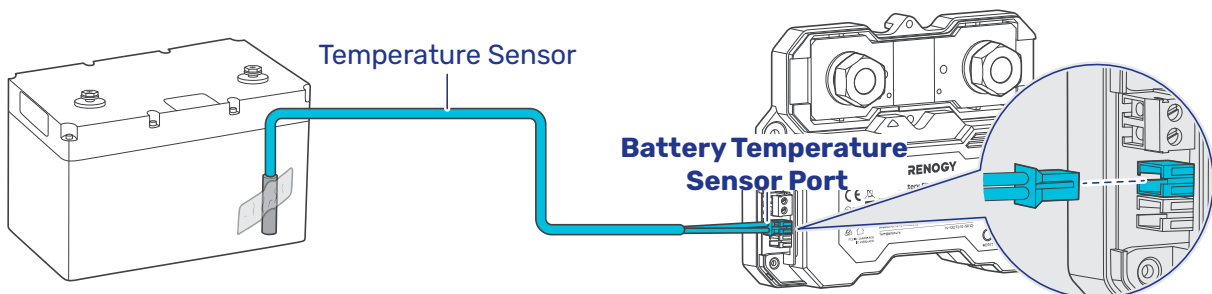

4.7. Connect the Shunt to the Starter Battery Positive (Optional)

STEP-1 Install the B+ wire on the shunt B2 terminal.

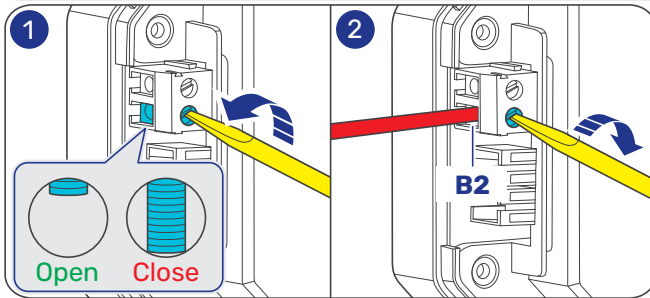

Renogy Battery Shunt 300

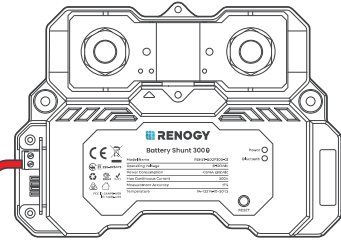

B2 Wire

STEP-2 Install the B+ wire on the starter battery positive.

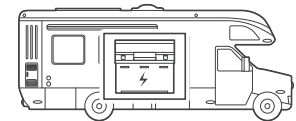
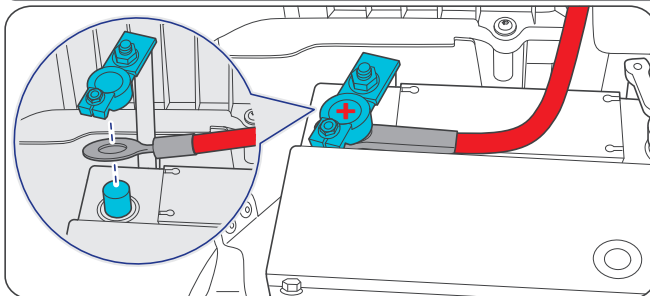

Starter Battery

4.8. Mount the Shunt (Optional)

To guarantee system safety, mounting the shunt to a proper location is recommended. You can choose a proper mounting site on demand.

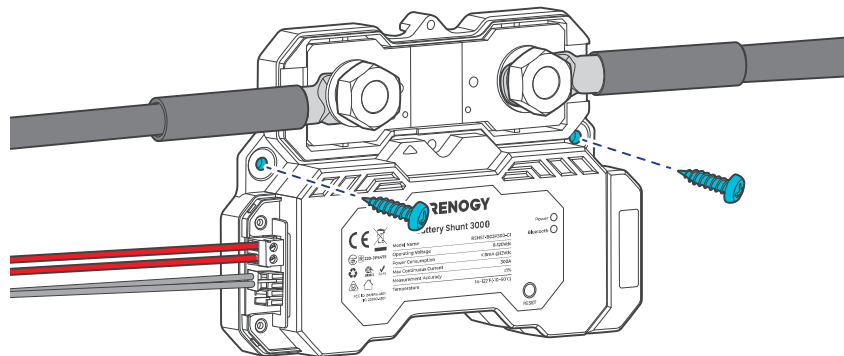

4.9. Install the Covers

■ Install the Lower Cover

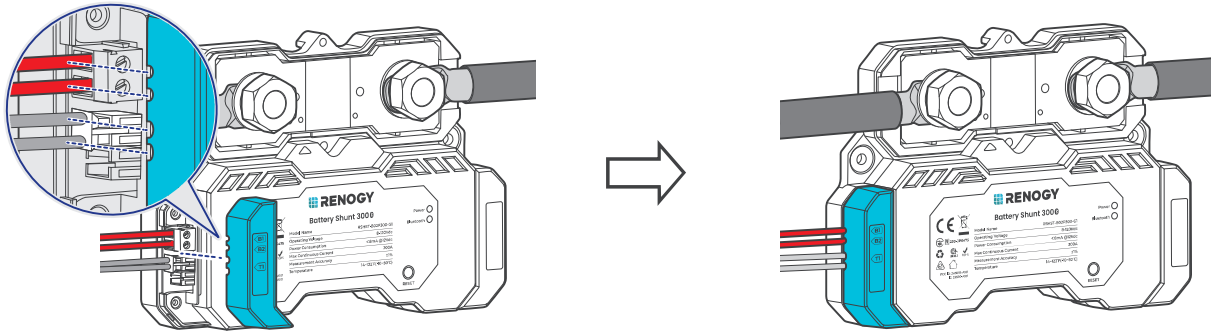

■ Install the Upper Cover (Optional)

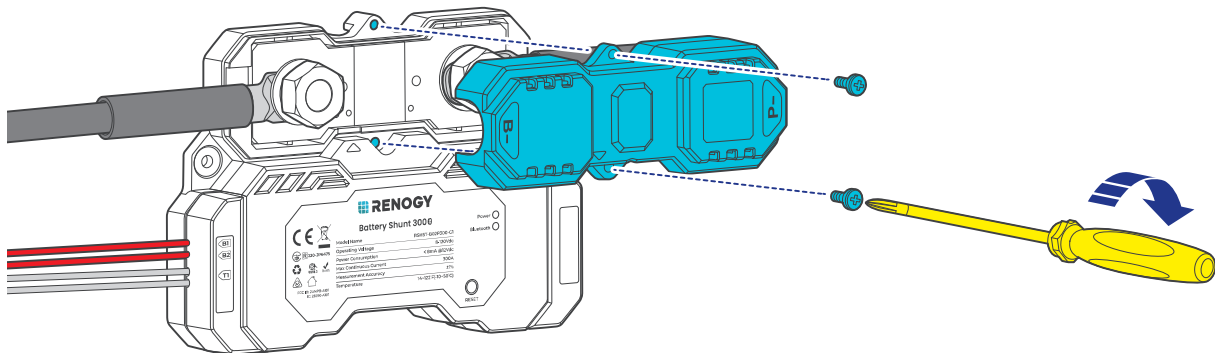

Installing the Upper Cover is optional in cases where the terminals are not enclosed by the cover.

5. Configuration

5.1. Power On

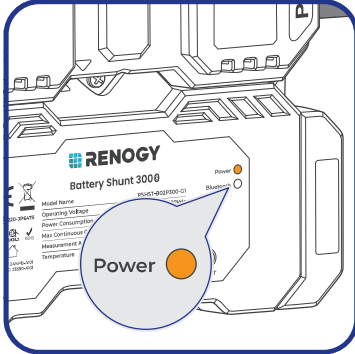

Power on all devices in your power system, and the Battery Shunt is powered up automatically with the Power LED Indicator lighting up.

5.2. Pairing with DC Home or Renogy ONE

For initial use, set the “Rated Battery Ah” (rated battery capacity) on the app prior to other operations. Rated Battery Ah should be the same as the rated capacity of the specific battery you use. For details, refer to the battery user manual.

Initial Pairing

For initial startup, follow the steps below to pair the shunt with the DC Home app or Renogy ONE.

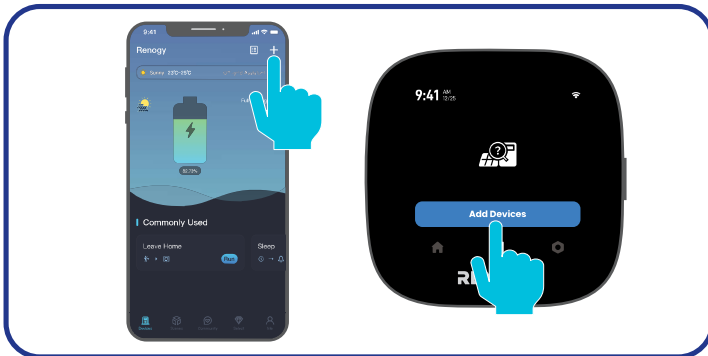

Step 1: On DC Home or Renogy ONE, navigate to “Add Devices”.

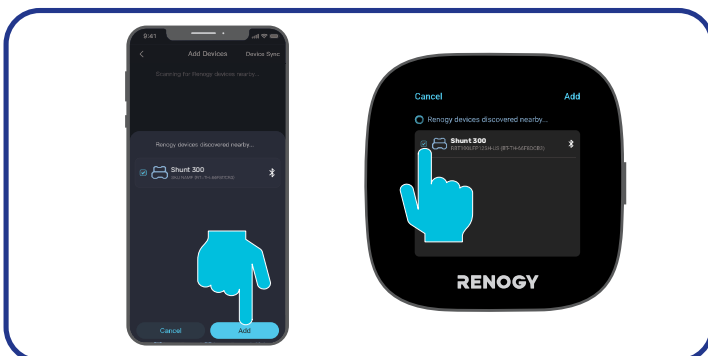

Step 2: Scan and pair the shunt with the Renogy ONE or DC Home app.

Pairing with Another Device

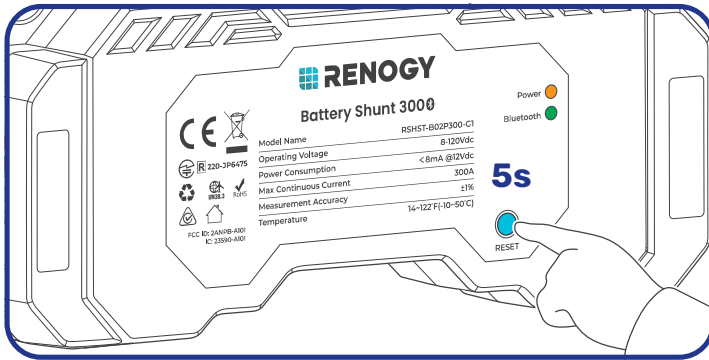

Step 1: Remove the shunt from the DC Home app or ONE. Alternatively, you can press and hold RESET on the shunt for 5s.

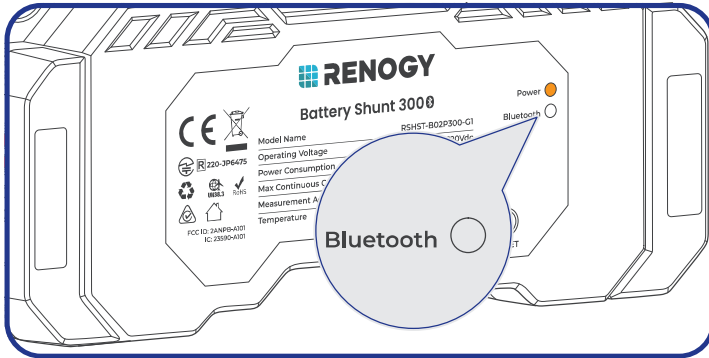

Step 2: After the Bluetooth LED turns off, redo scanning and pairing.

5.3. Energy Monitoring

Depending on the specific application, the shunt can establish either short-range or long-range communication connections with monitoring devices. These monitoring devices including RENOGY ONE Core and DC Home facilitate real-time monitoring, programming, and complete system management, offering comprehensive control and enhanced flexibility.

i The version of the DC Home app might have been updated. Illustrations in the user manual are for reference only. Follow the instructions based on the current app version.

Download and login to the DC Home app.

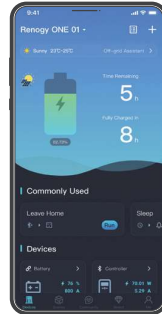

DC Home App



Short-Range Monitoring via DC Home App

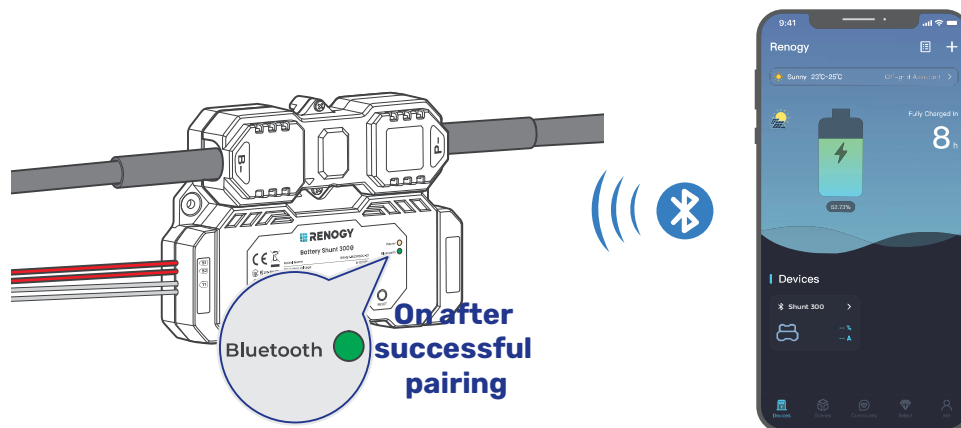
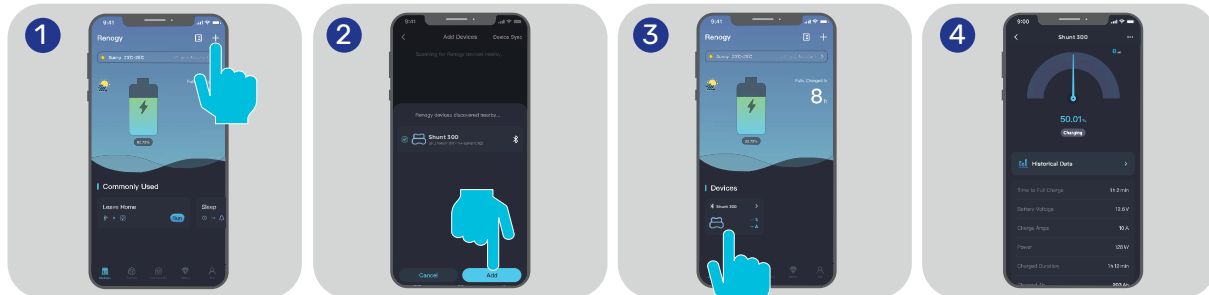

Wireless Long-Range Monitoring

If long-range communication and programming are required, connect the shunt to RENOGY ONE Core (sold separately) through Bluetooth, and the RENOGY ONE Core to the DC Home app through Wi-Fi.

Recommended Components



*RENOGY ONE Core

- i** Components marked with "*" are available on renogy.com.
- i** For instructions on Renogy ONE Core, see [Renogy ONE Core User Manual](#).
- i** Make sure the shunt does not communicate with any other device.

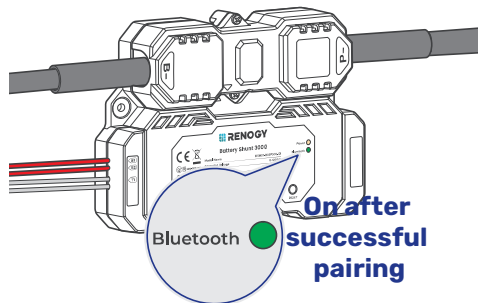

5.4. SOC Synchronization

To ensure reliable readout of the SOC of your battery, SOC synchronization is required, especially for batteries that have been used for an extended period.

A battery's capacity can degrade over time, so even if the battery may charge to full capacity, its actual capacity might not be as high as when it was new. For instance, a new battery rated at a full capacity of 100Ah can only charge to 90Ah after a year of use. In this case, recalibrating the SOC is required, using 90Ah as the new reference point, rather than the original 100Ah.

SOC synchronization should be performed in the following scenarios:

- During the initial shunt installation
- After there has been an interruption in the voltage supply to the DC Home or Renogy ONE
- When the battery has not been fully charged
- When the DC Home or Renogy ONE has not detected that the battery has been fully charged because the "Charging Amps" has been set incorrectly.

In this case, review the settings and make sure the battery regularly receives a full charge.

■ DC Home app

In the DC Home app, follow the steps below to synchronize the battery SOC in your system:

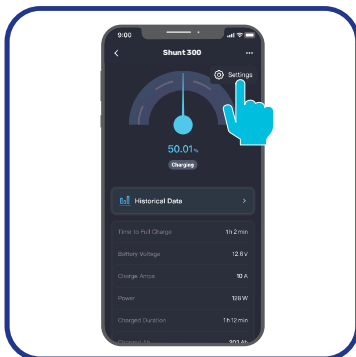

Step 1: Tap the shunt details page. Tap "... > Settings" in the upper-right corner of the page.

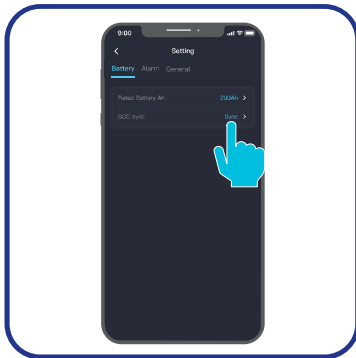

Step 2: Under "Battery", tap **Sync** in "SOC sync".

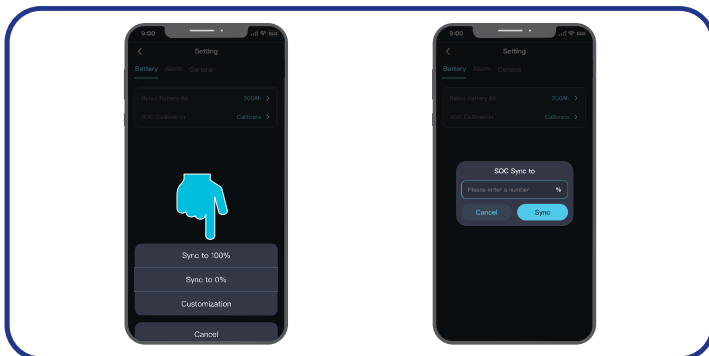

Step 3: You can choose "Sync to 100%", "Sync to 0%", "Customization" or "Cancel". It is recommended that you customize the SOC to match the actual SOC of your battery. Allowed value ranges from 0 to 100.



Step 4: Tap “Sync” to complete the synchronization.

Renogy ONE

In Renogy ONE, follow the steps below to synchronize the battery SOC in your system:



Step 1: Tap the shunt details page. Tap “...” in the upper-right corner of the page.

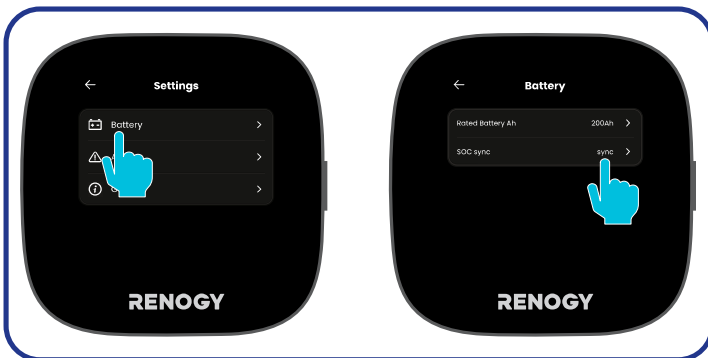

Step 2: Under “Battery”, tap **Sync** in “SOC sync”.

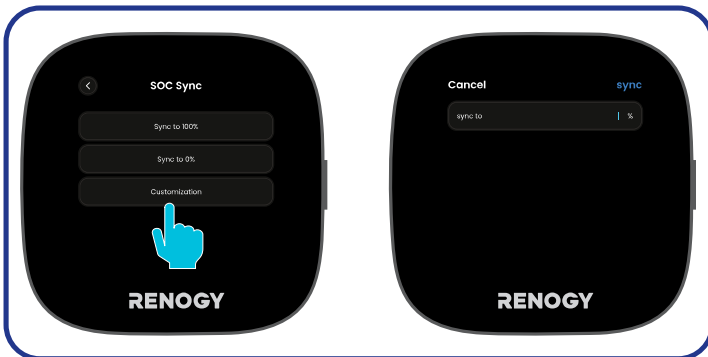

Step 3: You can choose “Sync to 100%”, “Sync to 0%”, “Customization” or “Cancel”. It is recommended that you customize the SOC to match the actual SOC of your battery. Allowed value ranges from 0 to 100.



Step 4: Tap “Sync” to complete the synchronization.

i The version of the DC Home app and Renogy ONE might have been updated. Illustrations in the user manual are for reference only. Follow the instructions based on the current app version.

5.5. Essential Alarm Settings

The battery shunt provides diverse alarms to protect your battery from high temperature or voltage. Most settings can stay their factory default, but you can customize them to better serve your needs.

On DC Home app or Renogy ONE Core, go to "... > **Settings > Alarm**" to configure essential alarms listed in the table below.

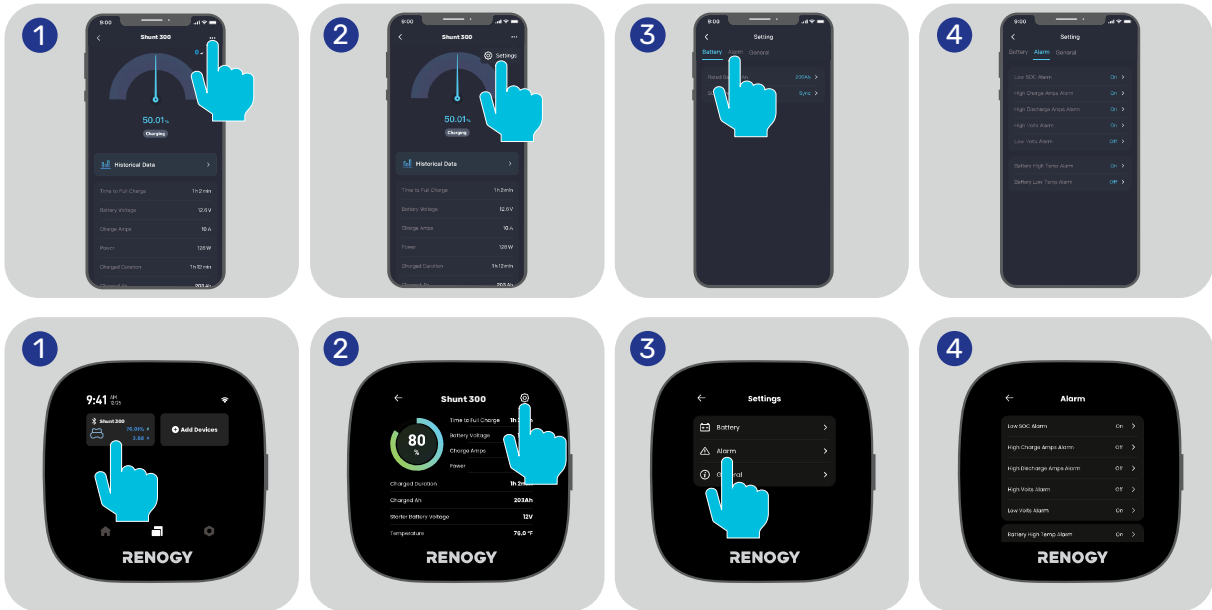

Alarm	Value	Description
Low SOC Alarm	<p>Range: 0% to 99%</p> <ul style="list-style-type: none"> ● Default trigger value: 50%. ● Default release value: 55% 	<p>The Low SOC Alarm activates when the battery SOC falls below the designated “Trigger Value” threshold and deactivates when the battery SOC surpasses the Release Value.</p> <p>Release Value = Trigger Value + Hysteresis Value</p> <p>Hysteresis value range: 0.5% to 5%</p>

Alarm	Value	Description
High Volts Alarm	Range: 0V to 100V Default High Volts Alarm values vary depending on the connected battery. <ul style="list-style-type: none"> ● For 12V batteries: 14.4V ● For 24V batteries: 28.8V ● For 48V batteries: 57.6V 	The High Volts Alarm activates when the battery voltage reaches the designated "Trigger Value" threshold and deactivates when the battery voltage drops below the Release Value. Release Value = Trigger Value - Hysteresis Value Hysteresis value range: 0.2V to 5V *The hysteresis value should be consistent with that in Low Volts Alarm.
Low Volts Alarm	Range: 0V to 100V Default Low Volts Alarm values vary depending on the connected battery. <ul style="list-style-type: none"> ● For 12V batteries: 11.2V ● For 24V batteries: 22.4V ● For 48V batteries: 44.8V 	The Low Volts Alarm activates when the battery voltage reaches the designated "Trigger Value" threshold and deactivates when the battery voltage rises above the Release Value. Release Value = Trigger Value + Hysteresis Value Hysteresis value range: 0.2V to 5V *The hysteresis value should be consistent with that in High Volts Alarm.
High Charge Amps Alarm	Range: 1A to 300A <ul style="list-style-type: none"> ● Default trigger value: 100A ● Default release value: 95A 	The High Charge Amps Alarm activates when the battery charge current rises above the designated "Trigger Value" threshold and deactivates when the charge current drops below the Release Value. Release Value = Trigger Value - Hysteresis Value Hysteresis value range: 1A to 5A
High Discharge Amps Alarm	Range: 1A to 300A <ul style="list-style-type: none"> ● Default trigger value: 300A ● Default release value: 295A 	The High Discharge Amps Alarm activates when the battery discharge current rises above the designated "Trigger Value" threshold and deactivates when the discharge current drops below the Release Value. Release Value = Trigger Value - Hysteresis Value Hysteresis value range: 1A to 5A
Battery Low Temp Alarm	Range: -10°C to 60°C (14°F to 140°F) <ul style="list-style-type: none"> ● Default trigger value: -10°C (14°F) ● Default release value: -5°C (23°F) 	The Battery Low Temp Alarm activates when the battery temperature drops below the designated "Trigger Value" threshold and deactivates when the battery temperature rises above the Release Value. Release Value = Trigger Value + Hysteresis Value Hysteresis value range: 1°C to 5°C *The hysteresis value should be consistent with that in Battery High Temp Alarm.

Alarm	Value	Description
Battery High Temp Alarm	<p>Range: -10°C to 60°C (14°F to 140°F)</p> <ul style="list-style-type: none"> ● Default trigger value: 55°C (131°F) ● Default release value: 50°C (122°F) 	<p>The Battery High Temp Alarm activates when the battery temperature rises above the designated “Trigger Value” threshold and deactivates when the battery temperature drops below the Release Value.</p> <p>Release Value = Trigger Value - Hysteresis Value</p> <p>Hysteresis value range: 1°C to 5°C</p> <p>*The hysteresis value should be consistent with that in Battery Low Temp Alarm.</p>

 The value ranges listed in the DC Home app or Renogy ONE Core prevail.

For each alarm, you can choose to either enable or disable the Buzzer when the alarm is triggered.

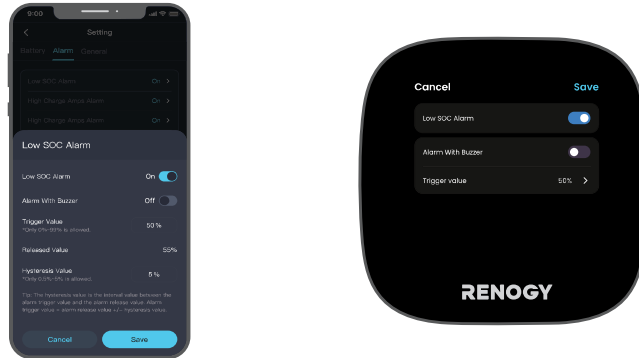

5.6. Historical Data

You can access the historical data of the connected battery via DC Home app or Renogy ONE Core.

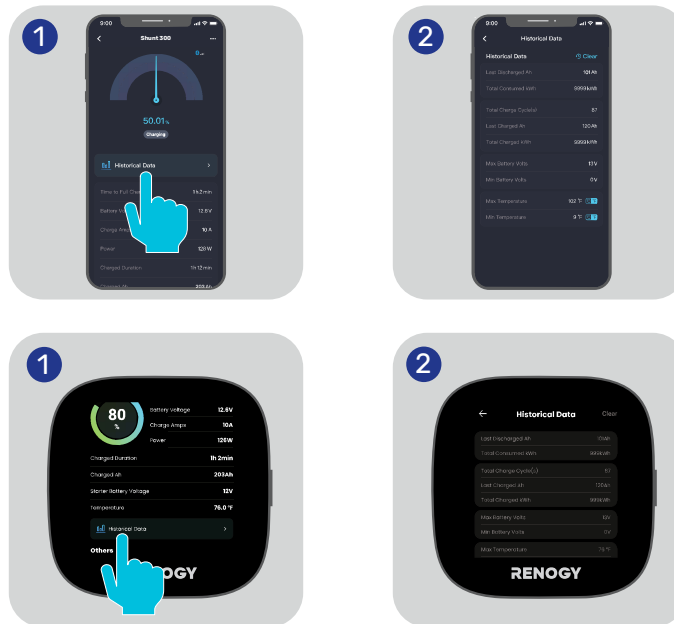

The following two parameters should be explained:

- Last Discharged Ah: This value represents the amount of electrical charge (in ampere-hours) that was consumed or discharged from the battery in the last discharge cycle. It is calculated by multiplying the discharge current (in amperes) by the duration of the discharge (in hours).

- Last Charged Ah: This value represents the amount of electrical charge (in ampere-hours) that was added or charged into the battery during the last charging cycle. It is calculated by multiplying the charge current (in amperes) by the duration of the charge (in hours).

i Maintaining historical data is essential for diagnosing potential battery issues. Avoid clearing the history unless replacing the battery to preserve valuable information about its performance and behavior over time.

5.7. Device Info

In "... > **Settings**", navigate to "**General**" where you can:

- Change the display name of your battery shunt
- Access the SN of your battery shunt
- Delete your battery shunt from Renogy ONE
- Reset your historical data.

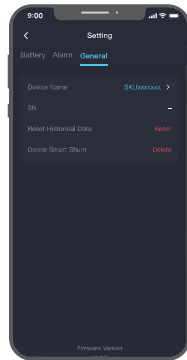

6. LED Indicators

Power LED Indicator

- **Off:** Power Off
- **Solid:** Power On

Power ○

Bluetooth ○

Bluetooth LED Indicator

- **Off:** No Bluetooth device connected
- **Solid:** Bluetooth connected

7. Troubleshooting

Issue	Possible Cause	Solution
In DC Home or Renogy ONE, the current is shown as negative when charging and positive when discharging.	Reverse polarity contact	Inspect for reverse contact on B- or P- terminals.
Incorrect temperature reading	The temperature sensor wiring is loose.	Confirm the Battery Temperature Sensor is properly installed.
Incorrect SOC reading	The battery capacity decreases as the charging and discharging cycles increase.	Re-configure the "Rated Battery Ah" to the capacity when the battery is fully charged.
Inaccurate sampling precision in large-current scenarios	Elevated ambient temperatures can affect sampling accuracy.	Ensure proper ventilation for the shunt and remove the upper cover if needed.
Abnormal current reading	PFC circuit abnormality or loose terminal connections	Remove the upper cover from the shunt, and check for abnormality on the PFC flexible circuit or loose terminal connections.

8. FAQ

■ What types of battery does the shunt work with?

Battery Shunt 300 works with all types of batteries and battery banks between 8V and 120V, providing the settings are calibrated correctly.

■ Can I monitor more than two batteries in parallel and series with one Battery Shunt 300?

Yes, you can monitor more than two batteries in parallel and series with one Renogy Battery Shunt 300. Just ensure that the total system voltage and maximum current draw are within the specified limits, and follow the installation instructions accordingly.

■ What is the maximum operational current for the battery shunt?

The maximum continuous current for the Battery Shunt is 300A, with a maximum peak current of 500A. Prolonged operation at currents exceeding 300A may lead to device overheating and damage, with a serious risk of fire. It is crucial to use the device within the specified specifications.

■ Why is the SOC or Time Remaining reading inaccurate?

First, check if the wiring is correctly installed according to the guidelines. If the reading is still inaccurate, you may need to reset the calibration. Charge the battery to 100%, and then recalibrate the battery capacity data through the Renogy ONE or DC Home app (for details, see "[5.4 SOC Synchronization](#)"). This process should help ensure more accurate readings.



For more FAQ, visit www.renogy.com/support/faq.

9. Dimensions and Specifications

9.1. Dimensions

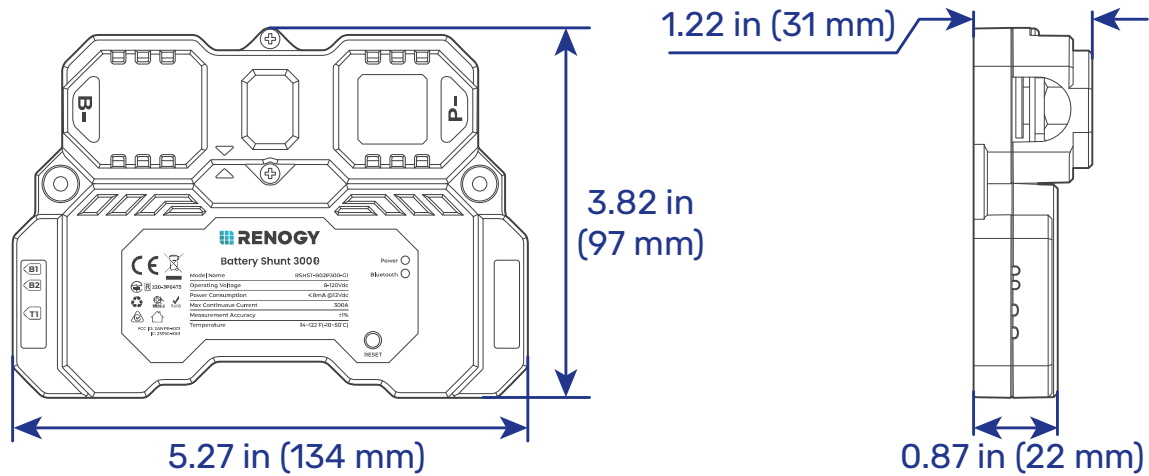

i Dimension tolerance: ± 0.5 mm (0.2 in)

9.2. Technical Specifications

Product Name	Renogy Battery Shunt 300
Model Name	RSHST-B02P300-G1
Operating Voltage	8V to 120V DC
Power Consumption	< 0.1 W
Communication	<ul style="list-style-type: none"> ● Bluetooth LE ● Bluetooth Mesh
Max Continuous Current	300A
Max Peak Current	500A (< 10s)
Current Accuracy	$\pm 1\%$
Current Resolution	0.01A
Battery Capacity (Ah)	1 to 6500Ah
Voltage Input Range	8V to 120V DC
Voltage Input Resolution	10 mV
Battery Connector	M10 bolts
Temperature Sensor Range	-4°F to 176°F (-20°C to 80°C)
Temperature Sensor Accuracy	$\pm 1\%$
Operating Temperature	14°F to 122°F (-10°C to 50°C)
Operating Humidity	0% to 95% RH
Operating Altitude	Less than 6,562 ft (2000m)
Installation	Surface mounting

Dimensions	5.27 x 3.82 x 1.22 in (134 x 97 x 31 mm)
Weight	0.57 lb (260g)
Certifications	CE, FCC ID, IC ID, RCM, TSCA, RoHS, UN38.3, and TELEC
Warranty	1 year

10. Maintenance

10.1. Inspection

For optimum performance, it is recommended to perform these tasks regularly.

- Check the appearance of the Renogy Battery Shunt 300 to make sure it is clean and dry.
- Ensure the Renogy Battery Shunt 300 is installed in a clean, dry and ventilated area.
- Ensure there is no damage or wear on the cables.
- Ensure the firmness of the connectors and check if there are any loose, damaged or burnt connections.
- Ensure that the Battery indicator and Fault indicator are in normal state.
- Ensure there is no any corrosion, insulation damage, or discoloration marks of overheating or burning.



Risk of electric shock! Make sure that all power is turned off before touching the terminals on the Renogy Battery Shunt 300.



In some applications, corrosion may exist around the contacts inside the connector. Corrosion can loosen springs and increase resistance, leading to premature connection failure. Please apply dielectric grease to each connector contact periodically. Dielectric grease repels moisture and protects the connector contacts from corrosion.

10.2. Cleaning

Follow the steps below to clean the Renogy Battery Shunt 300 regularly.

- Shut down Renogy Battery Shunt 300. If you clean the inside of the device, you need to disconnect the power supply.
- Wipe the charger housing and connector contacts with a damp cloth or non-metallic brush. If it is not clean after wiping, use a household cleaner.
- Dry the Renogy Battery Shunt 300 with a clean cloth and keep the area around the Renogy Battery Shunt 300 clean and dry.
- Make sure the Renogy Battery Shunt 300 is completely dry before reconnecting the connector to the Renogy Battery Shunt 300.

10.3. Storage

Follow the tips below to ensure that the Renogy Battery Shunt 300 is stored well.

- Disconnect all connectors that are connected to the Renogy Battery Shunt 300.
- By applying dielectric grease to each connector contact, the dielectric grease repels moisture and protects the connector contacts from corrosion.

11. Emergency Responses

In the event of any threat to health or safety, always begin with the steps below before addressing other suggestions.

- Immediately contact the fire department or other relevant emergency response team.
- Notify all people who might be affected and ensure that they can evacuate the area.

 Only perform the suggested actions below if it is safe to do so.

11.1. Fire

1. Disconnect all cables connected to the Renogy Battery Shunt 300.
2. Put out the fire with a fire extinguisher. Acceptable fire extinguishers include water, CO₂, and ABC.

 Do not use type D (flammable metal) fire extinguishers.

11.2. Flooding

1. If the Renogy Battery Shunt 300 is submerged in water, stay away from the water.
2. Disconnect all cables connected to the Renogy Battery Shunt 300.

11.3. Smell

1. Disconnect all cables connected to the Renogy Battery Shunt 300.
2. Make sure nothing is in contact with the Renogy Battery Shunt 300.
3. Ventilate the room.

11.4. Noise

1. Disconnect all cables connected to the Renogy Battery Shunt 300.
2. Make sure no foreign objects are stuck in the Renogy Battery Shunt 300 connector.

Renogy Support

To discuss inaccuracies or omissions in this quick guide or user manual, visit or contact us at:

[G | renogy.com/support/downloads](https://renogy.com/support/downloads)

 contentservice@renogy.com

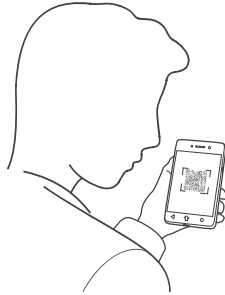

Questionnaire Investigation



To explore more possibilities of solar systems, visit Renogy Learning Center at:

[G | renogy.com/learning-center](https://renogy.com/learning-center)

For technical questions about your product in the U.S., contact the Renogy technical support team through:

[G | renogy.com/contact-us](https://renogy.com/contact-us)

 1(909)2877111

For technical support outside the U.S., visit the local website below:

[Canada | !\[\]\(b792654f2cef9719eabeb6c5be00811e_img.jpg\) | ca.renogy.com](https://ca.renogy.com)

[China | !\[\]\(7d1d6890825e83a6a4a51febe2dcc7f3_img.jpg\) | www.renogy.cn](https://www.renogy.cn)

[Australia | !\[\]\(2bae76de5ebbd5c4d7d47162f1673734_img.jpg\) | au.renogy.com](https://au.renogy.com)

[Japan | !\[\]\(b64b40baaee5acddc1eab8538ba84754_img.jpg\) | jp.renogy.com](https://jp.renogy.com)

[Other Europe | !\[\]\(84f47badaad7772cd95667a7c387a639_img.jpg\) | eu.renogy.com](https://eu.renogy.com)

[Germany | !\[\]\(28f72b996fc97883dfd9d4e8b1b16b4e_img.jpg\) | de.renogy.com](https://de.renogy.com)

[United Kingdom | !\[\]\(5d954b3e270654ad8ab0d5913161c03c_img.jpg\) | uk.renogy.com](https://uk.renogy.com)

FCC Statement

This device complies with Part 15 of the FCC Rules. Operation is subject to the following two conditions:

- (1) This device may not cause harmful interference, and
- (2) This device must accept any interference received, including interference that may cause undesired operation.

Warning: Changes or modifications not expressly approved by the party responsible for compliance could void the user's authority to operate the equipment.

This equipment has been tested and found to comply with the limits for a Class B digital device, pursuant to Part 15 of the FCC Rules. These limits are designed to provide reasonable protection against harmful interference in a residential installation. This equipment generates uses and can radiate radio frequency energy and, if not installed and used in accordance with the instructions, may cause harmful interference to radio communications. However, there is no guarantee that interference will not occur in a particular installation. If this equipment does cause harmful interference to radio or television reception, which can be determined by turning the equipment off and on, the user is encouraged to try to correct the interference by one or more of the following measures:

- (1) Reorient or relocate the receiving antenna.
- (2) Increase the separation between the equipment and receiver.
- (3) Connect the equipment into an outlet on a circuit different from that to which the receiver is connected.
- (4) Consult the dealer or an experienced radio/TV technician for help.

FCC Radiation Exposure Statement

This equipment complies with FCC radiation exposure limits set forth for an uncontrolled environment. This equipment should be installed and operated with minimum distance 20cm between the radiator & your body.

RSS Standard

This device complies with Industry Canada license exempt RSS standard(s). Operation is subject to the following two conditions:

- (1) This device may not cause interference, and
- (2) This device must accept any interference, including interference that may cause undesired operation of the device.

The device is compliance with RF exposure guidelines, users can obtain Canadian information on RF exposure and compliance. The minimum distance from body to use the device is 20cm.



Renogy Empowered

Renogy aims to empower people around the world through education and distribution of DIY-friendly renewable energy solutions.

We intend to be a driving force for sustainable living and energy independence.

In support of this effort, our range of solar products makes it possible for you to minimize your carbon footprint by reducing the need for grid power.



Live Sustainably with Renogy

Did you know? In a given month, a 1kW solar energy system will...



Save 170 pounds of coal from being burned



Save 300 pounds of CO₂ from being released into the atmosphere



Save 105 gallons of water from being consumed



Renogy Power PLUS

Renogy Power Plus allows you to stay in the loop with upcoming solar energy innovations, share your experiences with your solar energy journey, and connect with like-minded people who are changing the world in the Renogy Power Plus community.



@Renogy Solar



@renogyofficial



@Renogy

Renogy reserves the right to change the contents of this manual without notice.

Manufacturer: RENOGY New Energy Co.,Ltd
Address: No.66, East Ningbo Road Room 624-625 Taicang German
Overseas Students Pioneer Park JiangSu 215000 CN



eVatmaster Consulting GmbH
Battinistr. 30
60325 Frankfurt am Main, Germany
contact@evatmaster.com

Manufacturer: RENOGY New Energy Co.,Ltd
Address: No.66, East Ningbo Road Room 624-625 Taicang German
Overseas Students Pioneer Park JiangSu 215000 CN



EVATOST CONSULTING LTD
Office 101 32 Threadneedle Street,
London, United Kingdom, EC2R 8AY
contact@evatost.com



FCC ID: 2ANPB-A101

IC: 23590-A101