

VMAXTANKS™

Portable Power Supply

Ideal for Tailgating, Camping & Emergency Power

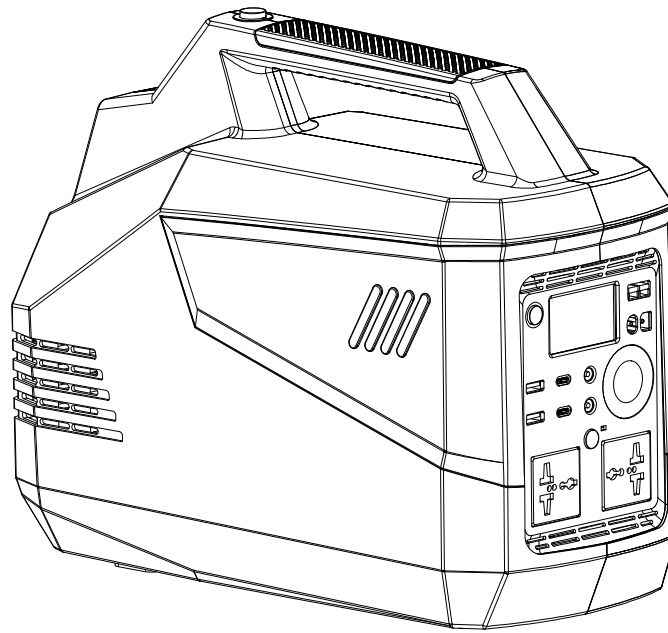

VPG750

User Manual





Dear Customer,

Thank you for choosing a VMAX Power generator! VMAX portable generators feature advanced lithium-ion battery technology and are an ideal portable power supply solution for indoor and outdoor activities. VMAX Power Generators are great for camping, tailgating and other outdoor activities. Furthermore, they can also be used as critical backup power in an emergency. Please carefully read and follow the instructions before using VMAX portable generators.

* Please use the included charger to fully charge your VMAX portable generator.

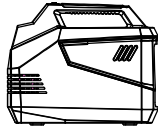
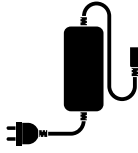
* Please read this manual before using your VMAX portable generator.

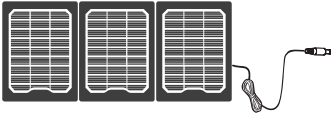
1 What's inside the box

Packing List		
 VPG750	 Charger	 Manual
Optional Accessories		
 Solar Panel	 5-in-1 USB cable	 DC Light

2 VPG750 Parts List

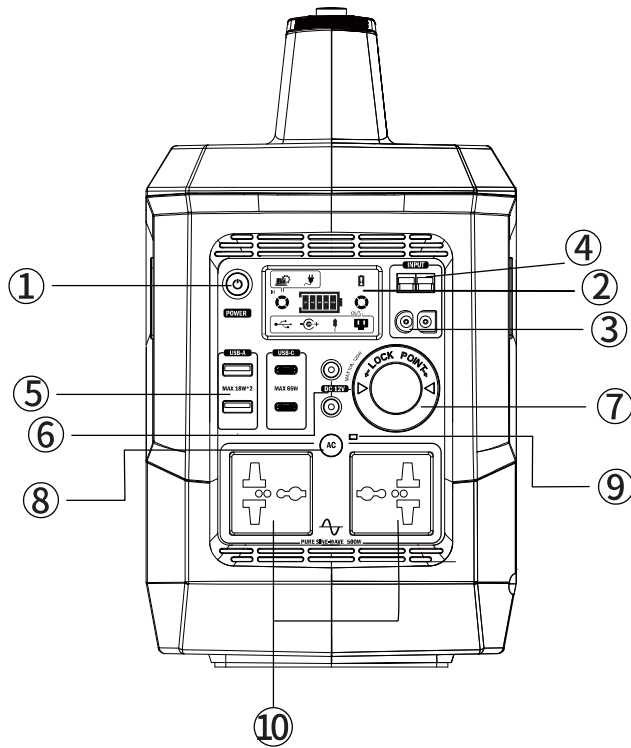

1. ON/OFF power switch
2. LCD screen
3. AC Charger input
4. Solar charging input
5. USB outputs
6. 12V DC outputs
7. Cigar lighter output
8. AC output button
9. AC output indicator
10. AC outputs

Please refer to below respective outlet types

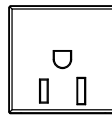

USA, MEX,
CAN & JPN

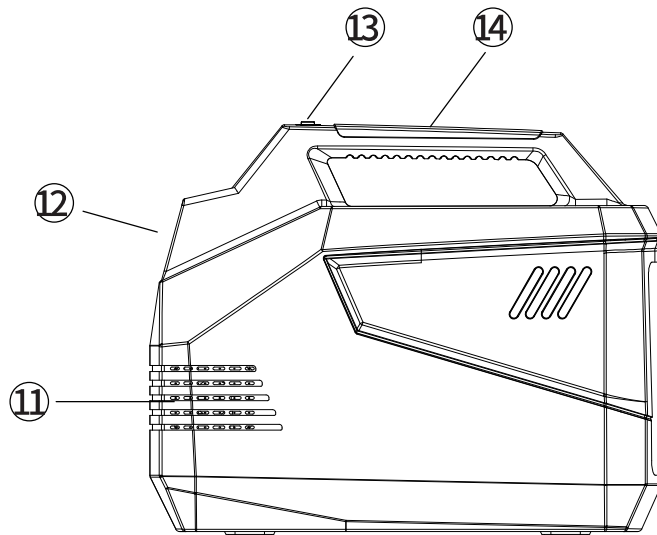

11. Cooling fan
12. Light
13. Light button
14. Handle

3 Using the VPG750

- * When battery capacity is below 20%, AC outputs will be automatically disabled.
- * When battery capacity is below 5%, DC (USB & 12V) outputs will be automatically disabled.
- * When DC is in use or AC is on, the discharging indicator on the right side of LCD screen will rotate ().

Power On

Press for 3 seconds to turn on the VPG750.

During the start-up process, all the icons on the LCD screen will display.

The LCD screen will turn to normal display if all functions are normal.

Using AC Output

Press the AC output button, an LED indicator will illuminate and the AC output icon () on the LCD screen will be activated, the AC ports are now active.

When you finish using AC ports, press the AC output button to turn off the AC output.

The interval time between pressing AC output button on/off should not be less than 5 seconds.

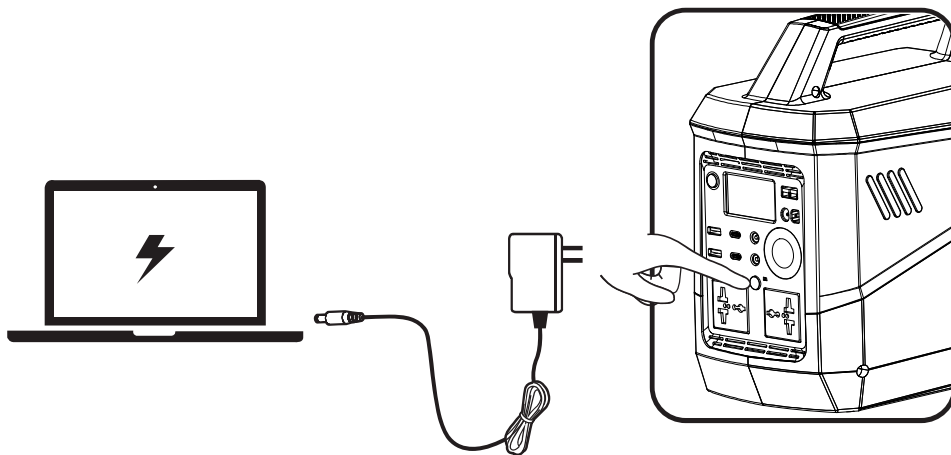

Using 5V Output

USB outputs can be used to charge your devices. When the VPG750 detects the load, the USB icon () on the LCD screen will be activated. The VPG750 has both USB-A and Type-C ports. Please see the technical specifications for output parameters on Page 9.

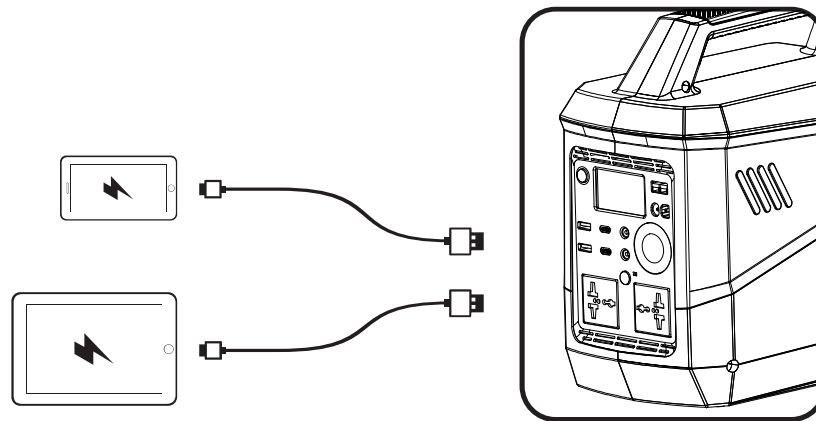

Using 12V DC Output

12V DC outputs can be used directly to charge your DC devices. When the VPG750 detects the load, the DC icon () on the LCD screen will be activated.

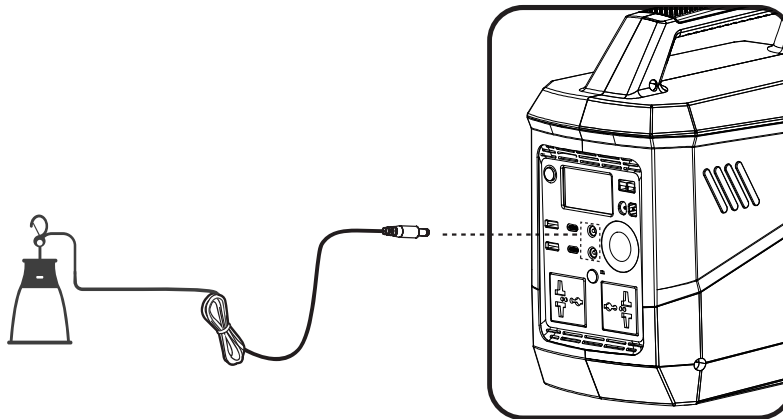

Using 12V DC Cigar Lighter Output

12V DC cigarette lighter outputs can be used directly to charge your devices. When the VPG750 detects the load, the 12V DC cigarette lighter icon () on the LCD screen will be activated. The maximum output power is 96W.

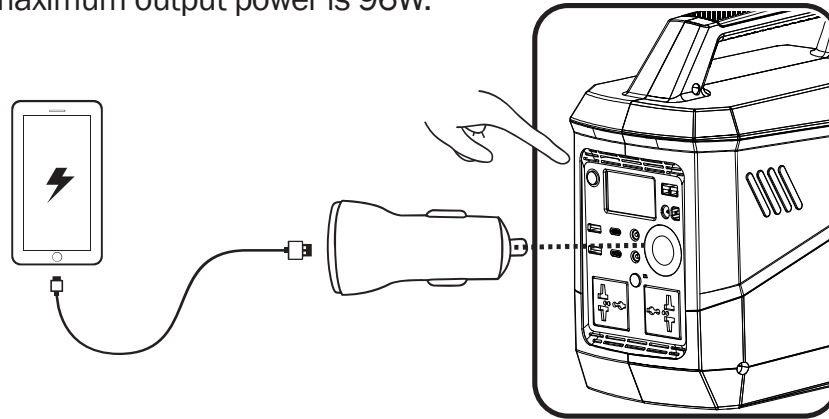

Lighting

The VPG750 has 5 lighting modes:

High brightness (100% power), Normal (50% power), Energy saving (25% power), Emergency flash and SOS. Press the light button hard to turn the light on/off, and press gently to shift between different modes.

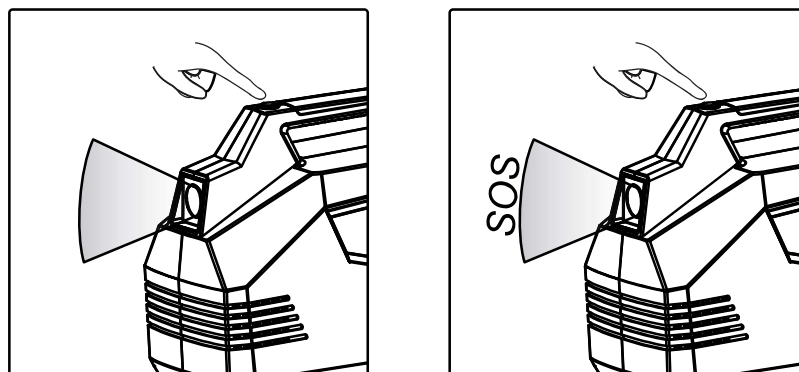

Power Off

When finished using your VPG750, please power it off by following these steps:

- ① Remove all the connected cables and loads.
- ② Press the AC Output button to turn off the AC output.
- ② Press and hold the ON/OFF button for 3 seconds to switch off.

Recharging

- **Wall Charging**

Important: Please do not discharge your VPG750 while charging!

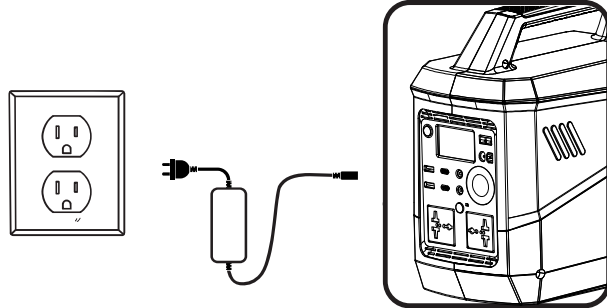

- **Solar Charging**

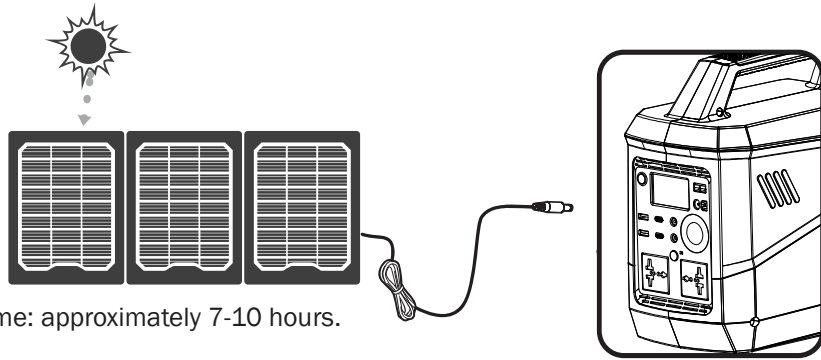

Recharge time: approximately 7-10 hours.

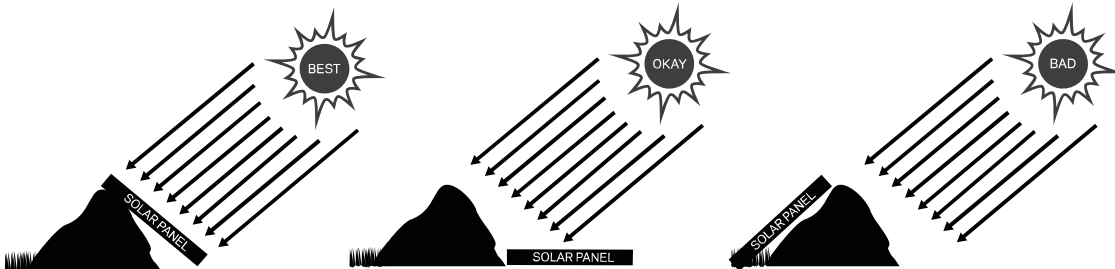

Place solar panels toward the sun at a proper angle to significantly improve solar charging efficiency.

The following estimated charging times are based on the most ideal conditions:

Model	40W Input	60W Input	80W Input	100W Input	120W Input
VPG750	20hrs-25hrs	12hrs-15hrs	10hrs-12hrs	8hrs-10hrs	10hrs-12hrs

4 LCD Screen Guide

Battery

Battery Power Indicator

Output

- USB in use
- 12V DC in use
- 12V Cigarette Lighter in use
- AC Power Indicator
- Icon rotates when DC power is in use or AC is on

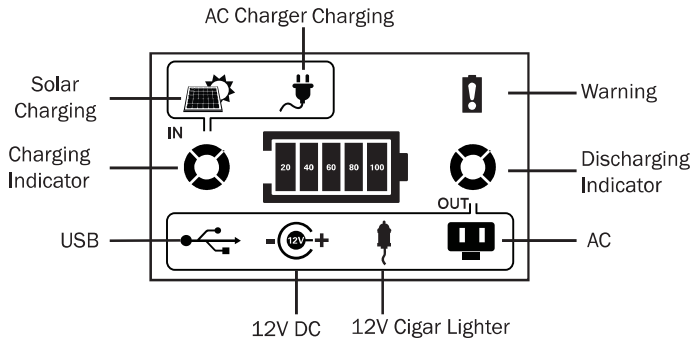







Input

- Solar Charging
- AC Charging
- Charging Indicator

Warning States

Item	Buzzer	Icon Display		Causes	
1	One buzzing sound every 3 seconds and buzzing stops after 30 seconds.		Battery icon flashes	Flashes for 30 seconds and then ceases when battery capacity $\leq 20\%$; Flashes continuously when battery capacity $\leq 5\%$.	
2			Battery and AC output icons flash, and current power display will restore after buzzing stops.	AC output is locked when battery capacity $\leq 20\%$	
3				Battery and cigar lighter icons flash	Use cigar lighter output when battery capacity $\leq 5\%$
4			Battery and 12V DC icons flash	Use 12V DC output when battery capacity $\leq 5\%$	
5			Battery and USB icons flash	Use USB output when battery capacity $\leq 5\%$	
6	Three buzzing sounds every 3 seconds and buzzing stops after 30 seconds.		Warning and solar input icons flash	AC charging failure caused by one of any following reasons: 1) Charging voltage is out of allowable range; 2) Charging current is beyond the max. allowable value; 3) Solar charging port is over-temperature.	
7				Warning and charger icons flash	Charging failure caused by one of any following reasons: 1) Charging voltage is out of allowable range; 2) Charging current is beyond the max. allowable value; 3) AC charging port is over-temperature.
8			Warning and AC icons flash	AC output failure caused by one of any following reasons: 1) Overload; 2) Short-circuit; 3) Inverter is protected due to over-temperature; 4) Communication between inverter and display board is interrupted.	















9	Three buzzing sounds every 3 seconds and buzzing stops after 30 seconds.			Warning and cigar lighter icons flash	Cigar output failure caused by one of any following reasons: 1) Overload; 2) Short-circuit.
10				Warning and 12V DC icons flash	12V DC output failure caused by one of any following reasons: 1) Overload; 2) Short-circuit; 3) Reverse plug through 12V DC port.
11				Warning and USB icons flash	USB output failure caused by one of any following reasons: 1) Overload; 2) Short-circuit; 3) Over-voltage.
12				Warning and Battery icons flash(power icon normally displays)	Communication between battery voltage acquisition board and display board is interrupted.
13				Warning, Battery and Power icons flash (power icon displays current power)	Battery alarm due to over-temperature protection or low-temperature protection.

Troubleshooting

No.	Faults	Causes	Solutions
1	Power-up Failure	Under-voltage Protection	Please charge VPG750.
		Abnormal Load Protection	Please remove the loads and recharge VPG750. If the problem can not be solved, please ask for customer service.
		Product Failure	Please contact VMAX USA for repair or replacement
2	Charger Fault	Unmatched Charger	Please only use the authorized charger.
		Charger Failure	Please contact your local dealer to replace the charger.
		Abnormal Power Supply or Connection	Please re-connect the charger. If the problem cannot be solved, please contact your local dealer to replace the charger.
3	Solar Panel Charging Fault	Over-voltage	Please use the recommended PV panel.
		Weak Sunlight	Please charge in sunny place.
		Solar Panel Failure	Please contact your local dealer to replace the PV panel.
		Abnormal Wiring-harness Connection	Please re-connect the wiring-harness. If the problem can not be solved, please contact your local dealer to replace the PV panel.
4	DC / AC Output Fault	Battery Under-voltage Protection	Please charge VPG750.
		Discharge Over-current Protection	Please check and ensure the powerof loads are within the allowed range.
		Over-temperature Protection	Please turn off VPG750. and restart after cooling down.
		Product Failure	Please contact VMAX USA for repair or replacement

5	Abnormal Icon Display	Abnormal Loads	Please remove the loads.
		Hardware Fault	Please contact VMAX USA for repair or replacement
		LCD Screen Failure	Please contact VMAX USA for repair or replacement
6	LCD Screen Fault	LCD Screen Failure	Please contact VMAX USA for repair or replacement

6 Specifications

 Capacity	VPG750: 786.24Wh (10.8V / 72.8Ah)
 Weight	VPG750: 16.5lbs (7.5kg)
 Dimensions	13.7 × 6.3 × 11.2 in(349 × 160 × 285 mm)
 Charger Input	VPG750:AC Wall Charger 12.6V / 10A
 Solar Input	12.5V-25V / Max. Power up to 125W
 USB Output	2 x 5V 2.4A / 9V 2A / 12V 1.5A
 USB Type-C	2 x 20V 3.25A / 15V 3A / 12V 3A / 9V 3A / 5V 3A
 DC Output	2 x 12V  5A / 60W
 Cigar Lighter	1 x 12V  10A / 120W
 AC Output	2 x 230V / 50Hz or 2 x 110V / 60Hz
	VPG750: 500W
 Lighting	1W High Brightness LED with SOS mode
 Temperature	Working: -10 ~ 45 °C (14 ~ 113 °F)
	Storage: 0 ~ 45 °C (32 to 113 °F)

Model	12V 3W Lighting	Stereo	PSP	Camera	Smart Phone	Tablet	Laptop	60W Fan	TV	Mini Bar
VPG750	230h+	500X+	90X+	160X+	70X+	17X+	8X+	12h+	7h+	15h+

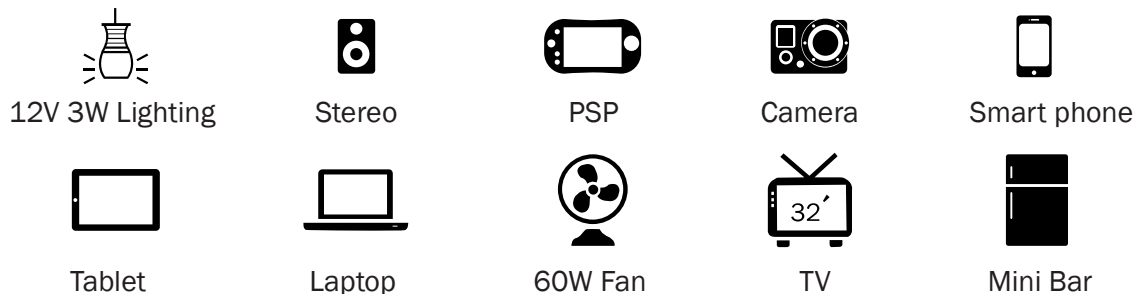

7 Attentions



Please use VPG750 to power/charge your devices within the following operating temperature range: 14 °F (-10 °C) to 113 °F (45 °C)



Please recharge VPG750 within the following operating temperature range: 32 °F (0 °C) to 113 °F (45 °C). Do not charge VPG750 when ambient temperature is above 113 °F (45 °C).



Please do not recharge VPG750 more than 12 hours, overcharging may shorten the service life.



Please use the included charger when charging via an AC wall outlet.



To maximize the service life of your VPG750, do not discharge below 20% state of charge. Note: Discharging below 20% is acceptable.



Please do not expose VPG750 to fire or high temperature (under direct sunlight or in vehicle under high heat), which may cause accidents such as fire and explosion.



Please recharge or use VPG750 at least once every four months for a longer service life.



Please ensure close supervision when using VPG750 around children or pets.



Please do not take on planes or aircraft.



Please do not disassemble, this may lead to risks such as fire, explosion, or electric shock.



Please avoid dropping VPG750.



Please charge and use in a dry and well ventilated area to avoid rain and water. Do not restrict ventilation in any way.

8 Warranty

Limited Warranty Conditions :

- The warranty is only valid if the product is used and handled correctly as per the included instructions.
- The warranty starts from the purchasing date. To make a warranty claim you must present the original invoice or sales receipt as evidence of your purchase.
- If any fault or failure happens, please contact the authorized seller or contact us directly to arrange a repair or replacement.
- The warranty is limited to the original purchaser when purchased from an authorized seller. The warranty is not transferable.

Warranty Exclusions:

- Warranty period exceeded.
- No valid purchase voucher (like invoice, etc.) can be provided.
- Repaired or modified by unauthorized agency or individual.
- Damage caused by using the unauthorized accessories, or not using the included charger.
- Damage caused by improper transportation, usage, operation, or storage.
- Damage caused by lightning, abnormal voltage, flood, fire, natural disaster, or accidental breakage, etc.
- Damage caused if used in environments where it is not intended for.
- Warranty does not apply to the battery cell unless the battery cell is fully charged within 30 days after your purchase and at least once every 6 months thereafter.

9 Disposal

Properly recycle your device at the end of its service life. Please dispose batteries by following local regulations.



10 Customer Service



18-month Limited Warranty



Lifetime Technical Support

Please contact us or visit our website for more information.

VMAX USA

5850 Sheldon Rd, Belleville, Mi 48111

1-888-862-9826 | info@vmextanks.com |

vmextanks.com

All rights reserved.